

Quick Installation Guide

H.264 Megapixel Surveillance Camera

MODEL NO. TL-SC3430

Package Contents

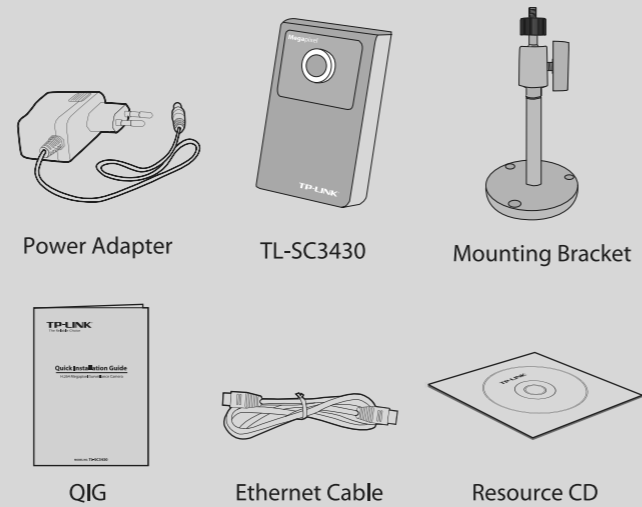

(*The pictures are for reference only.)

System Requirement

The following operating systems are supported:

- Windows XP
- Windows Vista
- Windows 7
- Windows 98
- Windows 2000
- Windows 2003
- Windows Me
- Mac
- Linux

The following browsers are supported:

- Microsoft Internet Explorer
- FireFox
- Safari

1 Warning Before Installation

- Do not keep the Camera exposed to direct sunlight.

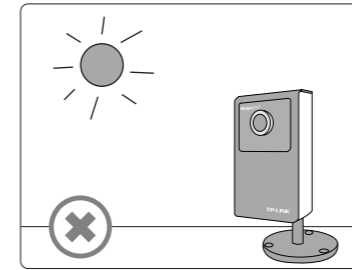

- Do not place the Camera in high humidity environments such as in a kitchen.

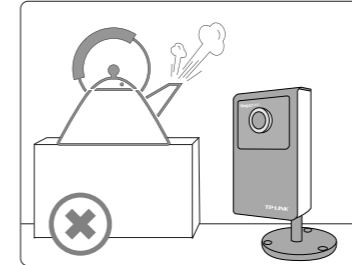

- Do not place the Camera where there are high temperatures such as near an oven.

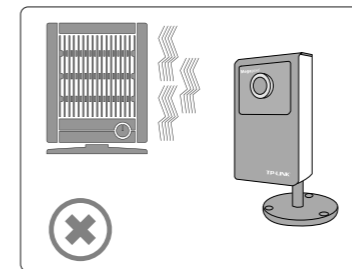

- We recommend to mount the camera where objects often pass the camera from the sides, and the camera towards the door or passage is much better, see the illustration below:

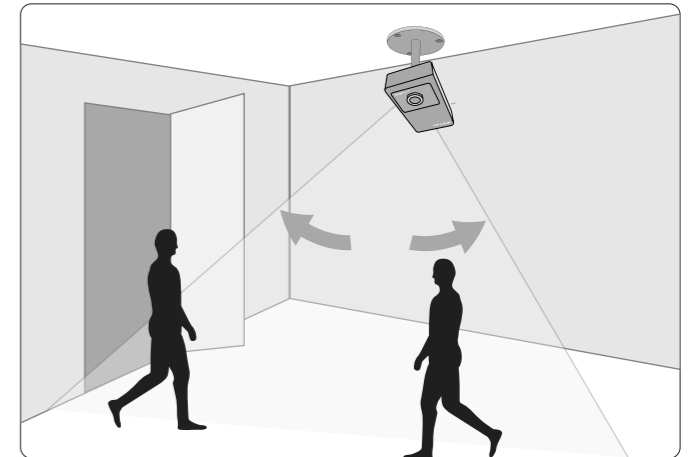

2 Physical Description

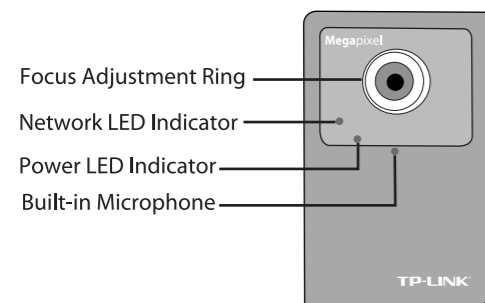

Item	Description
Power LED Indicator	<ul style="list-style-type: none"> Solid. The electrical power is on. Off. There is no electrical power.
Network LED Indicator	<ul style="list-style-type: none"> Solid. The network port is linked, but there is no activity. Blinking. There is traffic between the Camera and the network. Off. There is no network connection.
Reset Button	<p>Step 1. Re-power on the camera and wait for at least 45s until it restarts up normally.</p> <p>Step 2. Press the button for more than 10s, then it will be restored to factory defaults after rebooting automatically.</p>

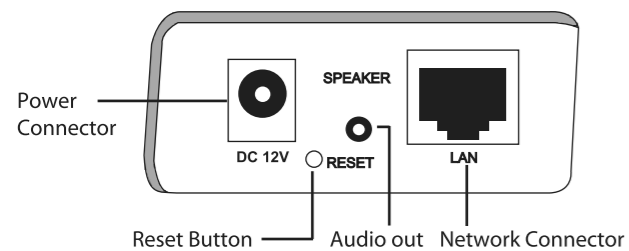

3 Hardware Connection

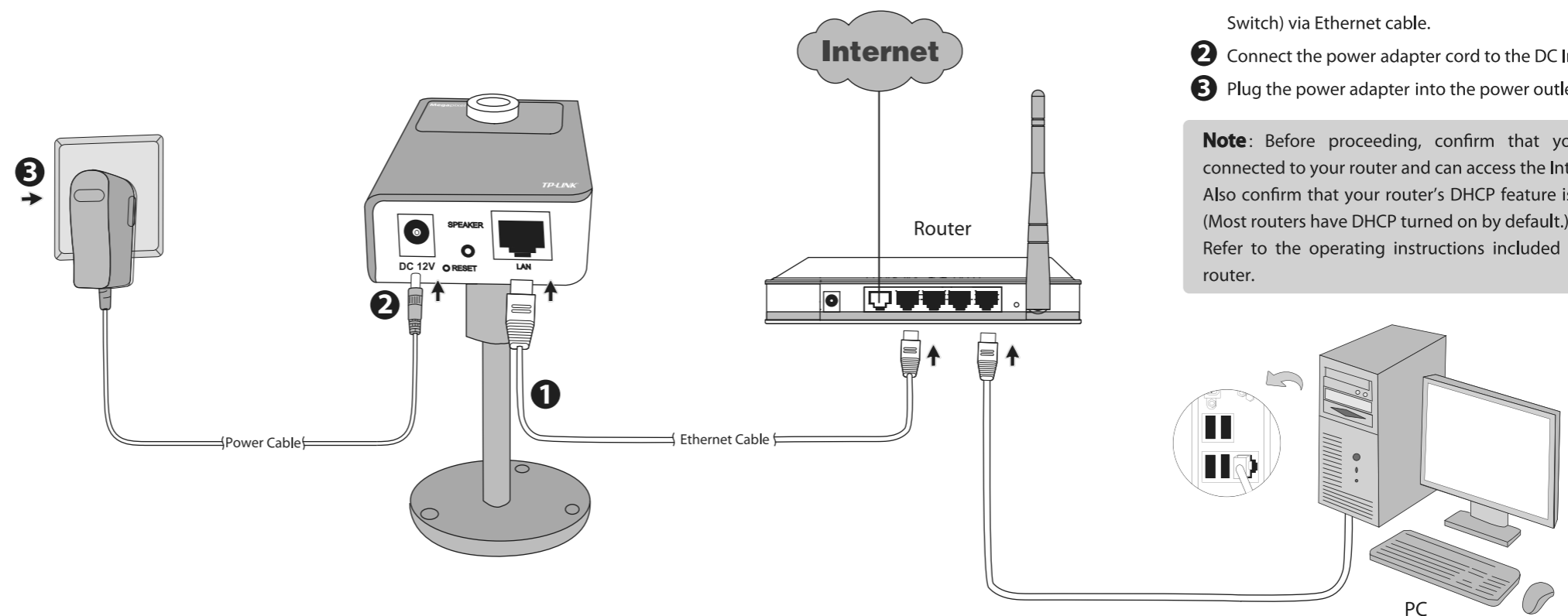

- Connect the camera to the LAN network (Router or Switch) via Ethernet cable.
- Connect the power adapter cord to the DC In jack.
- Plug the power adapter into the power outlet.

Note: Before proceeding, confirm that your PC is connected to your router and can access the Internet. Also confirm that your router's DHCP feature is enabled. (Most routers have DHCP turned on by default.) Refer to the operating instructions included with your router.

4 Software Installation

1 Insert the provided Resource CD into your CD-ROM drive.

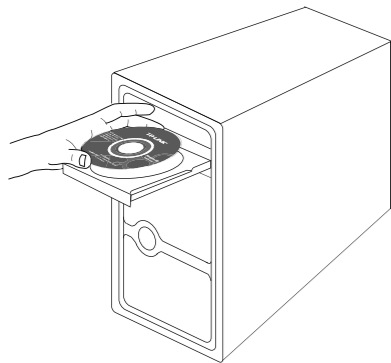

2 The Setup Wizard will automatically pop up on your computer's screen, then click "Intelligent IP Installer" (you can click the installer's manual later for advanced setting guide).¹



3 The Intelligent IP Installer window will appear. Please click "Next" to continue the program.

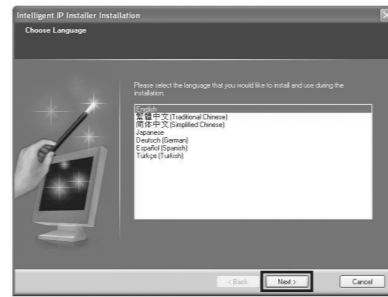

4 Select the optional program as needed. The default setting is highly recommended. Click "Next" to continue.²

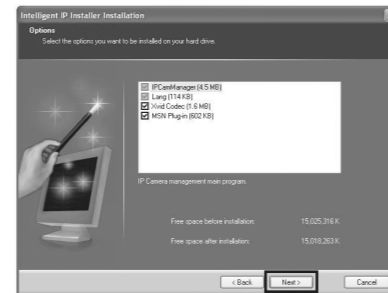

* If you want to be able to use MSN view, please select the last option.

5 Setup is completed. Click "Finish".

5 PC Configuration

We take IE in Windows XP for example, it is similar in Windows Vista/Windows 7.

1 Open IE browser. Click "Tools", then "Internet Options...".

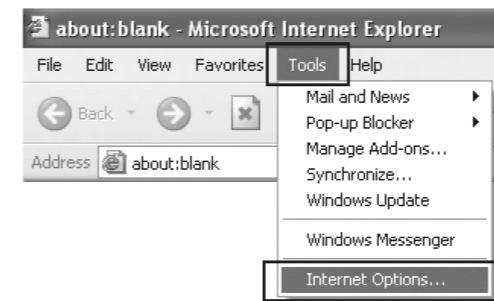

2 Click "Security" -> "Internet" -> "Custom Level...". Find the item "Download signed ActiveX controls" and make sure it is "Prompt", then click "OK".³

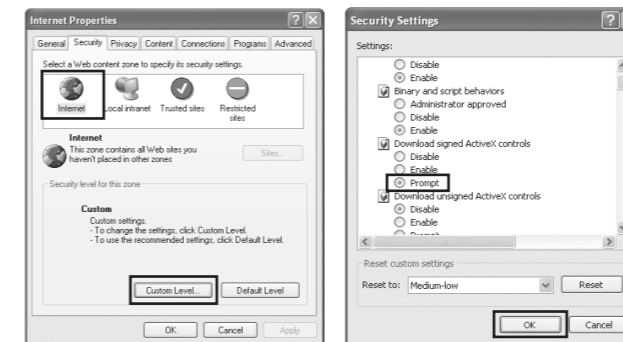

3 Click "Security" -> "Local intranet" -> "Custom Level...". Find the item "Download signed ActiveX controls" and make sure it is "Prompt", then Click "OK".³

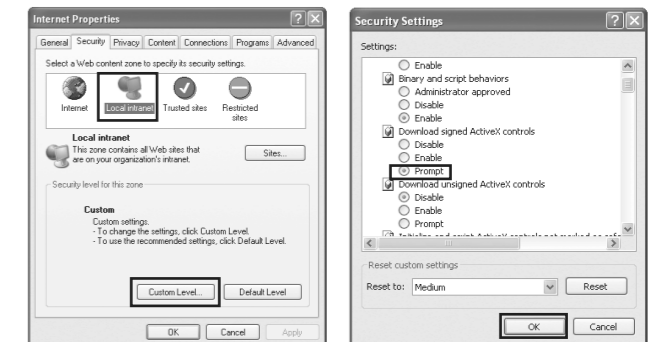

Notations:

1. If the CD does not automatically run with the installation window appearing, find the CD drive in the "My Computer" space and run it directly there.
2. A warning page will pop up automatically if the MSN program is not installed in your computer. You can reinstall the MSN Plug-in after the installation of the MSN.
3. The item "Download signed ActiveX controls" is "Prompt" by default, you can change it after the whole configuration.

6 Access the Camera using IP Installer

1 Click the icon of **Intelligent IP Installer** (installed in step 4) on the computer's Desktop.

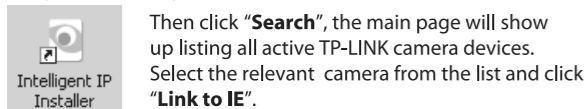

Then click "Search", the main page will show up listing all active TP-LINK camera devices. Select the relevant camera from the list and click "Link to IE".

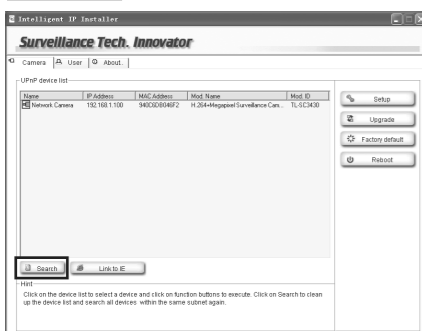

2 Enter your Username and Password to login to the IP Camera. (Default is **admin / admin**)



3 When accessing the IP Camera for the first time, a yellow information bar appears below the address bar, click the information bar, and select "Install ActiveX Control...".

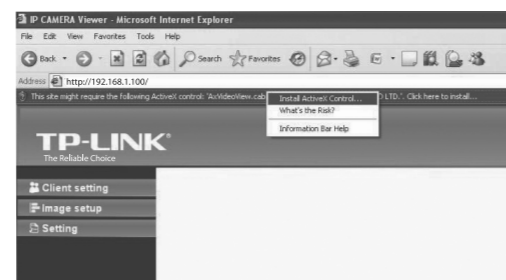

4 Click "Install".

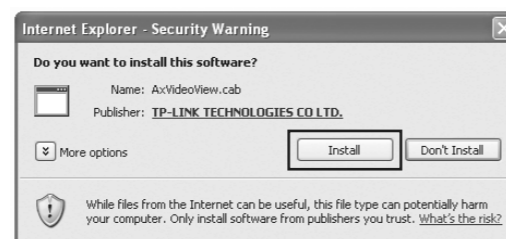

5 Live video displays in the centre of your web browser.



Note For further specific applications, please refer to the User Manual on resource CD. Moreover, **Application Guide** on resource CD will guide you to set up some typical applications step by step, so as to help you become familiar with the camera immediately.

For more details about Troubleshooting and Technical Support contact information, please log on to our Technical Support Website.

<http://www.tp-link.com/support/Support.asp>

Technical Support

- For more troubleshooting help, go to www.tp-link.com/support/faq.asp
- To download the latest Firmware, Driver, Utility and User Guide, go to www.tp-link.com/support/download.asp
- For all other technical support, please contact us by using the following details:

Global

Service Language: English
Tel: +86 755 26504400
E-mail : support@tp-link.com
Service time: 24hrs, 7days a week

Singapore

Tel: +65 62840493
E-mail: support.sg@tp-link.com
Service time: 24hrs, 7days a week

Malaysia

Tel: 1300 88 875465 (1300 88TPLINK)
E-mail: support.my@tp-link.com
Service time: 24 hours a day, 7days a week

Switzerland

Tel: +41 (0)848 800998
(German service)
E-mail: support.ch@tp-link.com
Fee: 4-8 Rp/min, depending on rate of different time

Service Time: Monday to Friday 9:00 AM to 6:00 PM. GMT+1 or GMT+2 (Daylight Saving Time)

* Except bank holidays in Hesse

Australia & New Zealand

Tel: AU 1300 87 5465
NZ 0800 87 5465
E-mail: support@tp-link.com.au
Service time: 24hrs, 7 days a week

USA/Canada

Toll Free: +1 866 225 8139
E-mail: support.usa@tp-link.com
Service time: 24hrs, 7days a week

UK

Tel: +44 (0) 845 147 0017
E-mail: support.uk@tp-link.com
Service time: 24hrs, 7days a week

Germany / Austria

Tel: +49 1805 875465 (German Service) / +49 1805 TPLINK
E-mail: support.de@tp-link.com
Fee: 0.14 EUR/min from the German fixed phone network and up to 0.42 EUR/min from mobile phone.

Service Time: Monday to Friday 9:00 AM to 6:00 PM. GMT+1 or GMT+2 (Daylight Saving Time in Germany)

* Except bank holidays in Hesse

TP-LINK TECHNOLOGIES CO., LTD.
www.tp-link.com