

# TP-LINK®

## User Guide

**TL-SC3430**

**H.264 Megapixel Surveillance Camera**



## **COPYRIGHT & TRADEMARKS**

Specifications are subject to change without notice. **TP-LINK®** is a registered trademark of TP-LINK TECHNOLOGIES CO., LTD. Other brands and product names are trademarks or registered trademarks of their respective holders.

No part of the specifications may be reproduced in any form or by any means or used to make any derivative such as translation, transformation, or adaptation without permission from TP-LINK TECHNOLOGIES CO., LTD. Copyright © 2010 TP-LINK TECHNOLOGIES CO., LTD.

All rights reserved.

<http://www.tp-link.com>

## FCC STATEMENT



This equipment has been tested and found to comply with the limits for a Class B digital device, pursuant to part 15 of the FCC Rules. These limits are designed to provide reasonable protection against harmful interference in a residential installation. This equipment generates, uses and can radiate radio frequency energy and, if not installed and used in accordance with the instructions, may cause harmful interference to radio communications. However, there is no guarantee that interference will not occur in a particular installation. If this equipment does cause harmful interference to radio or television reception, which can be determined by turning the equipment off and on, the user is encouraged to try to correct the interference by one or more of the following measures:

- Reorient or relocate the receiving antenna.
- Increase the separation between the equipment and receiver.
- Connect the equipment into an outlet on a circuit different from that to which the receiver is connected.
- Consult the dealer or an experienced radio/ TV technician for help.

This device complies with part 15 of the FCC Rules. Operation is subject to the following two conditions:

- 1) This device may not cause harmful interference.
- 2) This device must accept any interference received, including interference that may cause undesired operation.

Any changes or modifications not expressly approved by the party responsible for compliance could void the user's authority to operate the equipment.

## CE Mark Warning



This is a class B product. In a domestic environment, this product may cause radio interference, in which case the user may be required to take adequate measures.

# CONTENTS

<b>Package Contents</b> .....	<b>1</b>
<b>Chapter 1 Safety Instruction</b> .....	<b>2</b>
<b>Chapter 2 Minimum System Requirement &amp; Product Feature</b> .....	<b>3</b>
2.1 System Requirement .....	3
2.2 Product Features .....	3
2.3 Physical Overview .....	4
2.3.1 Front View .....	4
2.3.2 Bottom view .....	5
<b>Chapter 3 Using IP Camera via Web Browser</b> .....	<b>6</b>
3.1 Obtain the IP Address .....	6
3.2 Windows Web Browser .....	8
3.3 Mac Web Browser .....	9
<b>Chapter 4 Operating IP Camera via Mobile Phone</b> .....	<b>12</b>
4.1 Mobile Phone Viewing .....	12
4.1.1 3G Mobile Phone Streaming Viewing .....	12
4.1.2 2.5G Mobile Phone WAP Viewing .....	12
4.1.3 2.5G Mobile Phone Browser Viewing .....	12
4.2 Using IP Camera via iPhone .....	13
<b>Chapter 5 MSN Messenger</b> .....	<b>14</b>
<b>Chapter 6 Configuration of Main Menu</b> .....	<b>21</b>
6.1 Live View .....	21
6.1.1 Snapshot .....	21
6.1.2 Digital zoom in / out the image via the monitor window .....	22
6.1.3 Video play buttons .....	22
6.1.4 Audio buttons .....	22
6.2 Setting .....	23
6.3 Client Setting .....	24
6.3.1 Mode .....	24
6.3.2 View Size .....	24
6.3.3 Protocol .....	24
6.3.4 Video Buffer .....	24
6.4 Image Setup .....	25
6.4.1 Brightness .....	25
6.4.2 Contrast .....	25
6.4.3 Saturation .....	25
6.4.4 Sharpness .....	25
6.4.5 Default .....	25
<b>Chapter 7 Setting-Basic</b> .....	<b>26</b>
7.1 System .....	26
7.1.1 Information .....	26
7.1.2 Date / Time .....	27

7.1.3	Initialize .....	28
7.1.4	Language .....	29
7.2	Camera.....	29
7.2.1	General.....	30
7.2.2	H.264 .....	31
7.2.3	MPEG4.....	33
7.2.4	MJPEG .....	35
7.2.5	3GPP.....	36
7.2.6	Advanced .....	37
7.2.7	Playback.....	38
7.3	Network.....	39
7.3.1	Information .....	40
7.3.2	PPPoE.....	41
7.3.3	DDNS (Dynamic DNS) .....	42
7.3.4	UPnP (Universal Plug and Play).....	46
7.3.5	Bonjour .....	47
7.3.6	IP Notification .....	48
7.3.7	Messenger.....	50
7.4	Security.....	52
7.4.1	Account .....	52
7.4.2	HTTPS.....	53
7.4.3	IP Filter .....	54
<b>Chapter 8</b>	<b>Setting-Advanced .....</b>	<b>56</b>
8.1	FTP Client.....	56
8.1.1	General.....	56
8.1.2	Alarm Sending.....	57
8.1.3	Periodical Sending .....	59
8.2	SMTP.....	60
8.2.1	General.....	60
8.2.2	Alarm Sending.....	62
8.2.3	Periodical Sending .....	63
8.3	Network Storage .....	64
8.3.1	General.....	65
8.3.2	Alarm Sending.....	66
8.3.3	Periodical recording.....	68
8.4	Schedule.....	69
8.5	Alarm Buffer.....	69
8.6	Motion Detection.....	70
8.7	Audio Detection .....	71
8.8	System Log.....	72
<b>Chapter 9</b>	<b>Appendix.....</b>	<b>74</b>
<b>A. Frame-rate and Bitrate Table</b>	<b>– Help to set IPCamera with your network environment to access Internet.....</b>	<b>74</b>
A.1	Mega Mode .....	74
A.2	VGA Mode .....	76
<b>B. Storage Requirement Table</b>	<b>- Help to set Recording Storage System.....</b>	<b>78</b>

B.1 Mega Mode .....	78
B.2 VGA Mode .....	80
<b>C. System Requirement – Help to setup System .....</b>	<b>82</b>
C.1. 16 Channel IPCamera with CIF Performance .....	82
C.2. 16 Channel IPCamera with D1 Performance .....	82
<b>Europe – EU Declaration of Conformity.....</b>	<b>83</b>
<b>Federal Communication Commission Interference Statement .....</b>	<b>86</b>

## Package Contents

The follow items should be found in your package:

- TL-SC3430 H.264 Megapixel Surveillance Camera
- Power Adapter
- Mounting Bracket with three screws, a Lock Ring, a Brace and a Base Plate
- RJ45 Cable
- Quick Installation Guide
- Resource CD, including:
  - This User Guide
  - Application Guide
  - Other helpful information

 **Note:**

Make sure that the package contains the above items. If any of the listed items are damaged or missing, please contact your distributor.

# Chapter 1 Safety Instructions

## ➤ Before you use this product

This product has been designed with safety in mind. However, the electrical products can cause fires which may lead to serious body injury if not used properly. To avoid such accidents, be sure to heed the following.

## ➤ Legal Caution

Video and audio surveillance can be forbidden by laws that vary from country to country. Check the laws in your local region before using this product for surveillance purposes.

## ➤ Don't open the housing of the product

Don't try to open the housing or remove the covers which may expose yourself to dangerous voltage or other hazards.

## ➤ Don't use the accessories not recommend by the manufacturer

## ➤ Heed the safety precautions

Be sure to follow the general safety precautions and the "Operation Notice."

## ➤ Operation Notice - Operating or storage location

Avoid operating or storing the camera in the following locations:

- Extremely hot or cold places  
(Operating temperature: 0 °C to + 50 °C [32 °F to 122°F] )
- Exposed to direct sunlight for a long time, or close to heating equipment (e.g., near heaters)
- Close to water (e.g., near a bathtub, kitchen sink, laundry tub)
- Close to sources of strong magnetism
- Close to sources of powerful electromagnetic radiation, such as radios or TV transmitters
- Locations subject to strong vibration or shock

## ➤ In case of a breakdown

In case of system breakdown, discontinue use and contact your authorized dealer.

## ➤ In case of abnormal operation

- If the unit emits smoke or an unusual smell,
- If water or other foreign objects enter the cabinet, or
- If you drop the unit or damage the cabinet: 1 Disconnect the cable and the connecting cables. 2 Contact your authorized dealer or the store where you purchased the product.

## ➤ Transportation

When transporting the camera, repack it as originally packed at the factory or in materials of equal quality.

## ➤ Ventilation

To prevent heat buildup, do not block air circulation around the device.

## ➤ Cleaning

- Use a soft, dry cloth to clean the external surfaces of the device. Stubborn stains can be removed using a soft cloth dampened with a small quantity of detergent solution, then wipe dry.
- Do not use volatile solvents such as alcohol, benzene or thinners as they may damage the surface.



## Chapter 2 Minimum System Requirement & Product Feature

### 2.1 System Requirement

For normal operation and viewing of the network camera, it's recommended that your system meet these minimum requirements for proper operation:

Item	Requirements
CPU	Pentium 4 2.8GHz (or equivalent AMD)
Graphic Card	258 MB RAM graphic cards(or equivalent on-board graphic cards)
RAM	1G
Operating System	Windows 2000, Windows 2003, Windows XP, Windows Vista, Windows 7, and Mac OS X Leopard
Web Browser	Internet Explore 6 or later

 **Note:**

Please keep updating the latest Windows software and service package. (Ex: Net Framework, Windows Media Player, Enhance ActiveX Security)

### 2.2 Product Features

These easy-to-follow instructions make setup and operation quick and simple, so you'll also soon be enjoying the benefits of these product features:

SYSTEM	
<b>Resolutions</b>	H.264 / MPEG-4 / Motion JPEG: 4 resolutions from 1280 x 1024 to 320 x 240 via API and configuration web page 3GPP: 2 resolutions from 320 x 240 to 160 x120 via compatible cellphone.
<b>Screen Resolution</b>	Higher than 1024 * 720 pixels
<b>Compressing format</b>	H.264 / MPEG-4 / Motion JPEG
<b>Frame Rate</b>	Up to 15 fps at 1280 x 1024 Up to 30 fps at 640 x 480
<b>Image settings</b>	Rotation: Mirror, Flip, Mirror Flip
	Brightness / Contrast / Saturation / Sharpness
	Overlay capabilities: time, date, text and privacy image
<b>Image snapshot</b>	Yes
<b>Video Recording</b>	Yes
<b>Full Screen Viewing</b>	Yes
<b>Digital Zoom</b>	10x digital

<b>Audio</b>	Two-way (full / half duplex) with built-in microphone
	Audio compression: G.711 $\mu$ law, a law, and AMR
<b>Instant Messenger</b>	Support MSN Live View
<b>Mobile Phone Live View</b>	Through 2.5 WAP, 3GPP, 3G Streaming, and 3G Browser
<b>Alarm Sending</b>	FTP Client / SMTP / Network Storage
<b>Security</b>	Password Protecton / HTTPS encryption / IP Filter
<b>Alarm Buffer</b>	Recording image and audio file pre-and-post disconnection up to 5 sec.
<b>Supported protocols</b>	Bonjour, TCP/IP, DHCP, PPPoE, ARP, ICMP, FTP, SMTP, DNS, NTP, UPnP, RTSP, RTP, HTTP, TCP, UDP, 3GPP/ISMA RTSP
<b>Simultaneous Connection</b>	Up to 10 users
<b>Operating conditions</b>	0°C ~ 50 °C (32°F ~ 122 °F)
<b>HARDWARE</b>	
<b>Lens</b>	F1.8, 4.2mm Megapixel board lens
<b>LEDs</b>	5 $\phi$ LEDs x 6
<b>IR working distance</b>	5 M
<b>I / O</b>	1 in / 1 out
<b>Audio Output</b>	1
<b>Power</b>	12V DC, 1A, Max 5W

## 2.3 Physical Overview

### 2.3.1 Front View

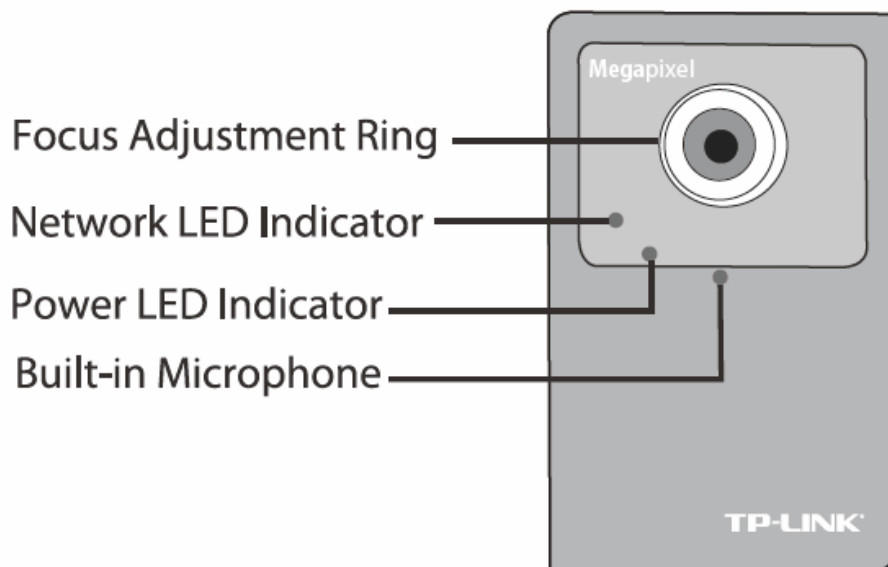

**Focus Adjustment Ring:** Adjust the focus ring to get a clear image.

**Network LED Indicator:** It lights up when the IP Camera is well connected to the network. It flashes when there are data being transmitted.

**Power LED Indicator:** It lights up when the IP Camera is powered on.

**Built-in Microphone:** The location where the voice from your partner comes out.

### 2.3.2 Bottom view

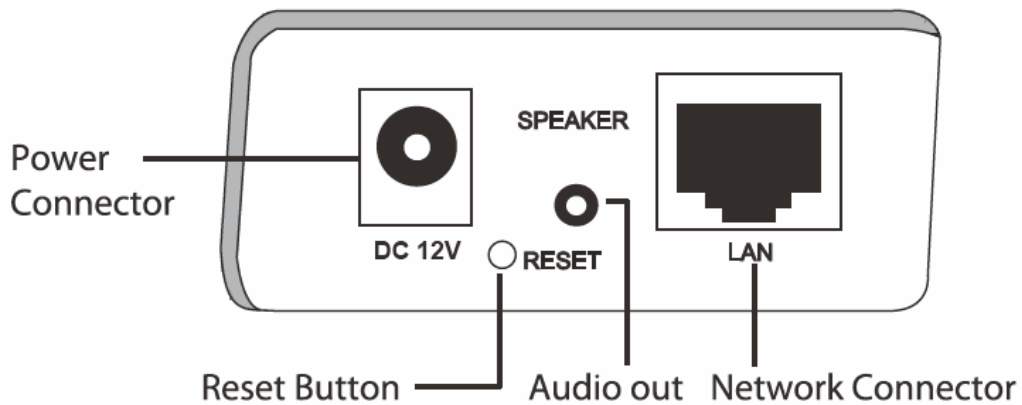

- **Power Connector:** The power connector is where you connect the power adapter.
- **RESET:** Please take the following steps to reset the camera to its defaults.
  - Step 1.** Make sure the camera is powered on for at least 30 seconds to complete its normal startup.
  - Step 2.** Keep the camera powered on, then press and hold the **Reset** button for more than 10 seconds. Afterwards release it, and the camera will be restored to factory defaults after rebooting.
- **Audio Out:** The Audio Out port is where the speaker is connected.
- **LAN (Network Connector):** Through this port, you can connect the IP Camera to your computer or the other Ethernet network devices.

## Chapter 3 Using IP Camera via Web Browser

### 3.1 Obtain the IP Address

1. Insert the provided CD into your CD-ROM driver. The Setup Wizard will automatically pop up on your computer's screen as shown in the figure below.

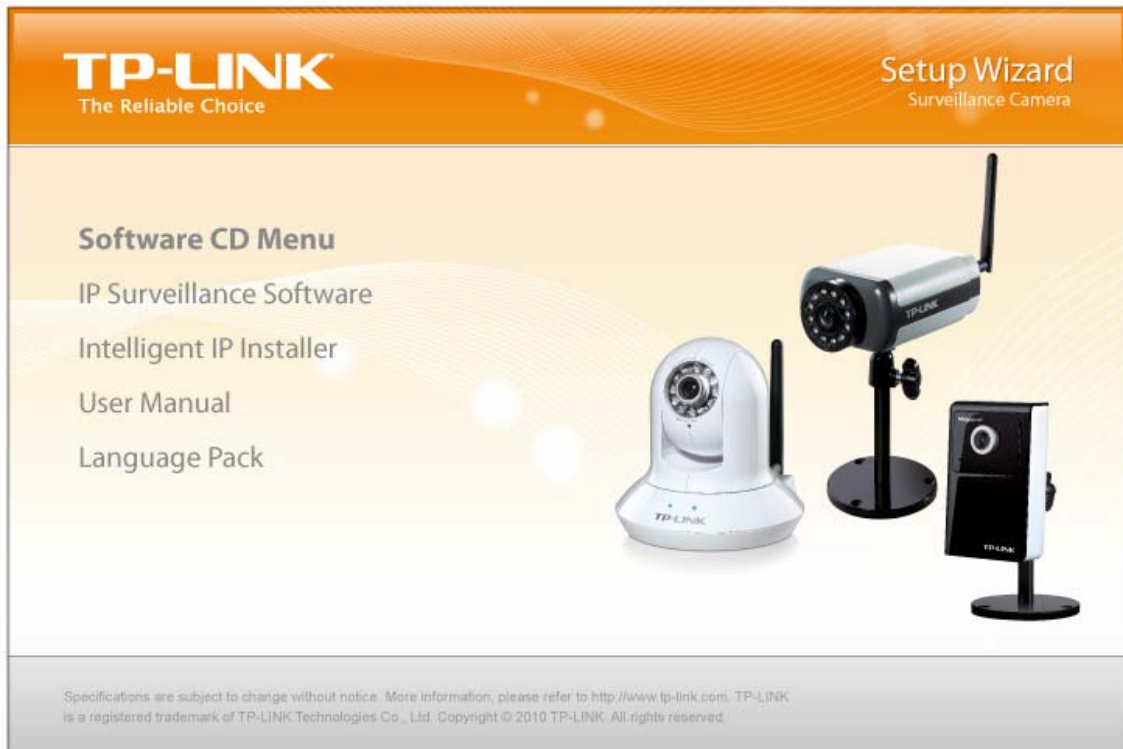

Figure 3-1

2. Choose the **Intelligent IP Installer**, and then the next screen appears. Click on **Intelligent IP Installer** to begin the installation.



Figure 3-2

3. After the installation is finished, click **Start > All Programs > TP-LINK >Intelligent IP Installer** to start using the program.

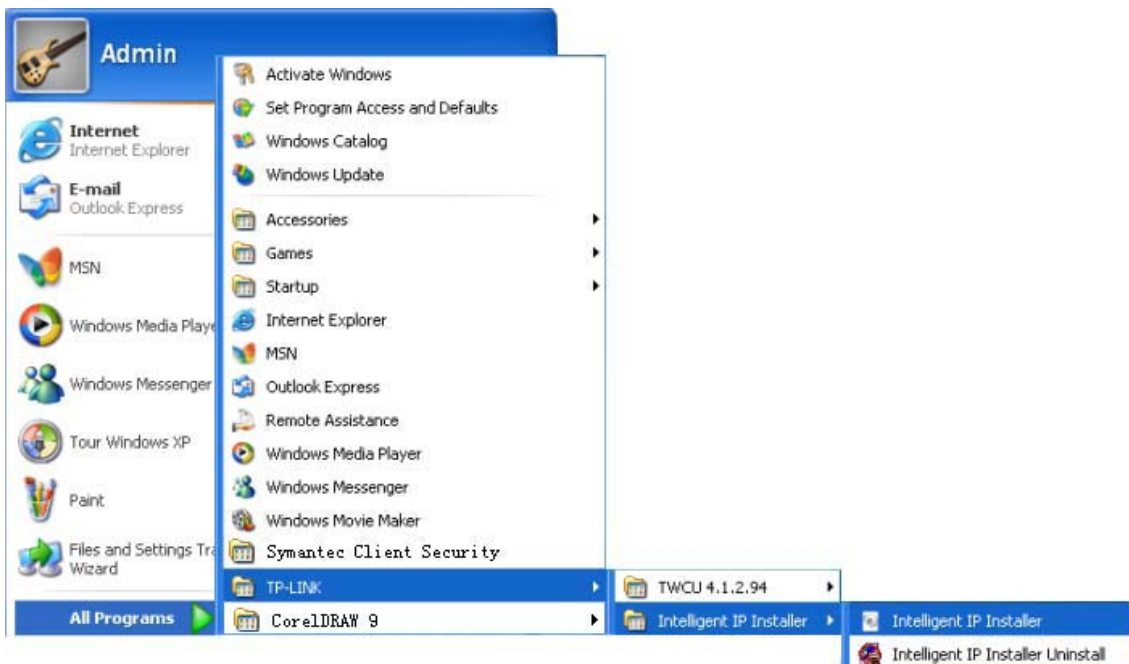

Figure 3-3

4. The following screen will then display. Click the **Search** button to search Network Cameras in the network; it displays Network Cameras information including IP Address.

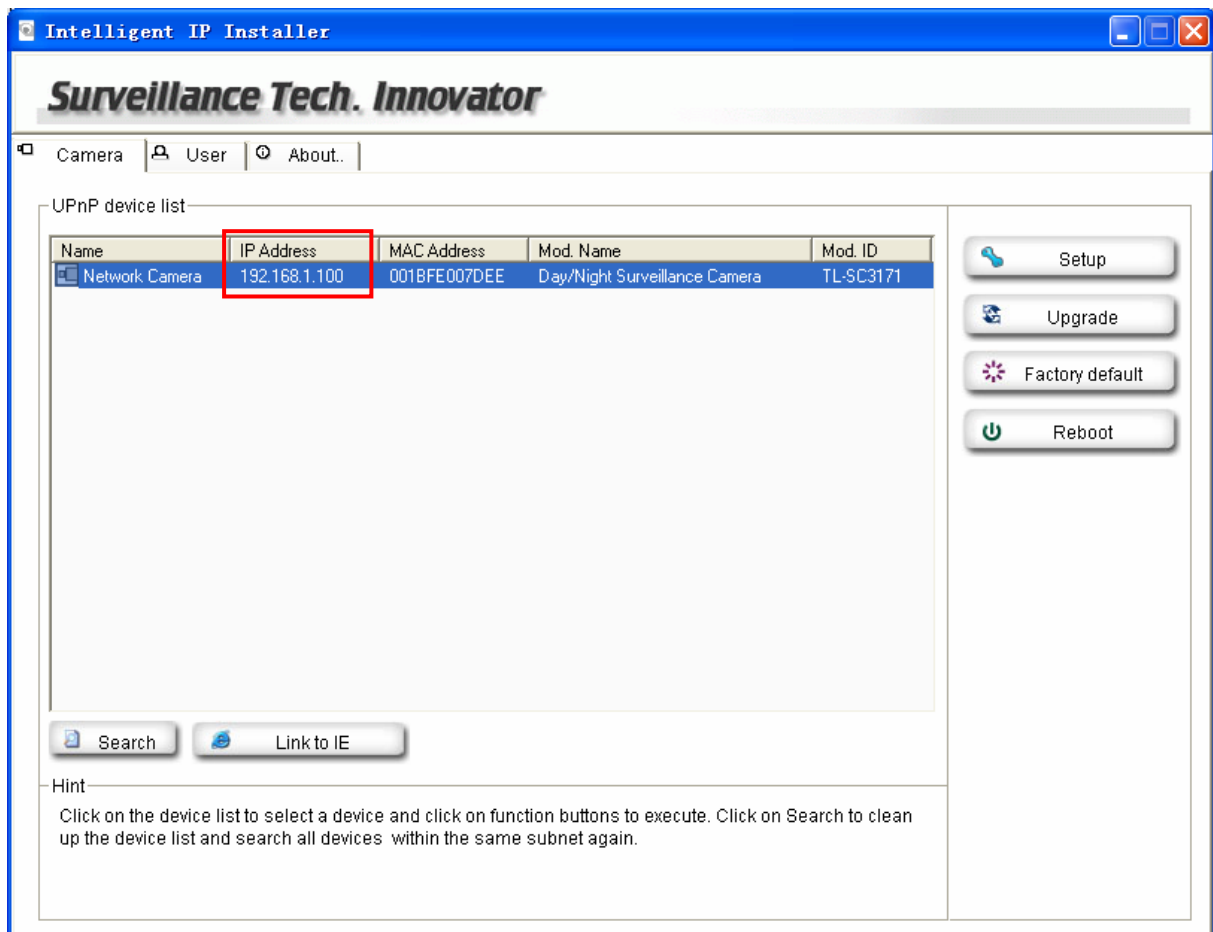
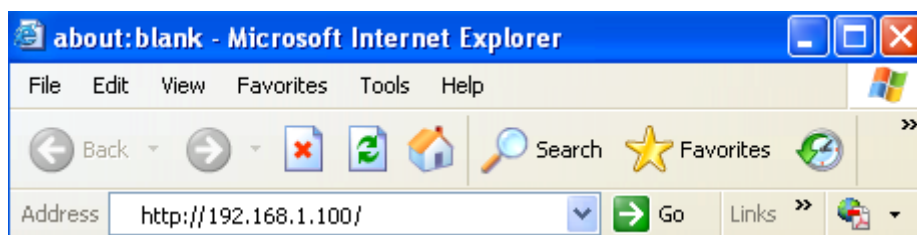

Figure 3-4

## 3.2 Windows Web Browser

- 1 Click **Link to IE** button in Figure 3-4 or launch your web browser, and enter the IP address or host name of the IP camera in the Location / Address field of your browser.



**Note:**

If you only want to view the video without accessing Setting screen, enter “http://<IP>/index2.htm” as your web URL.

- 2 Use the default account “**admin**” and default password “**admin**”.

**Note:**

The default user name “admin” and the password are set at the factory for the administrator. You can change them in the Account Menu. (Please check “**Setting** → **Basic** → **Security** → **Account**”)

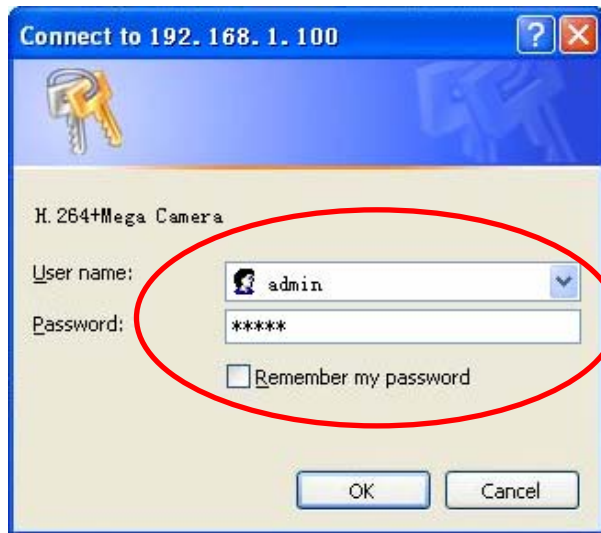

- 3 The monitor image will be displayed in your browser. In the far left side of main configuration are Setting, Client Setting, and Image Setup. For more details, you can check Chapter 6.2、 Chapter 6.3、 Chapter 6.4 and Chapter 6.5.

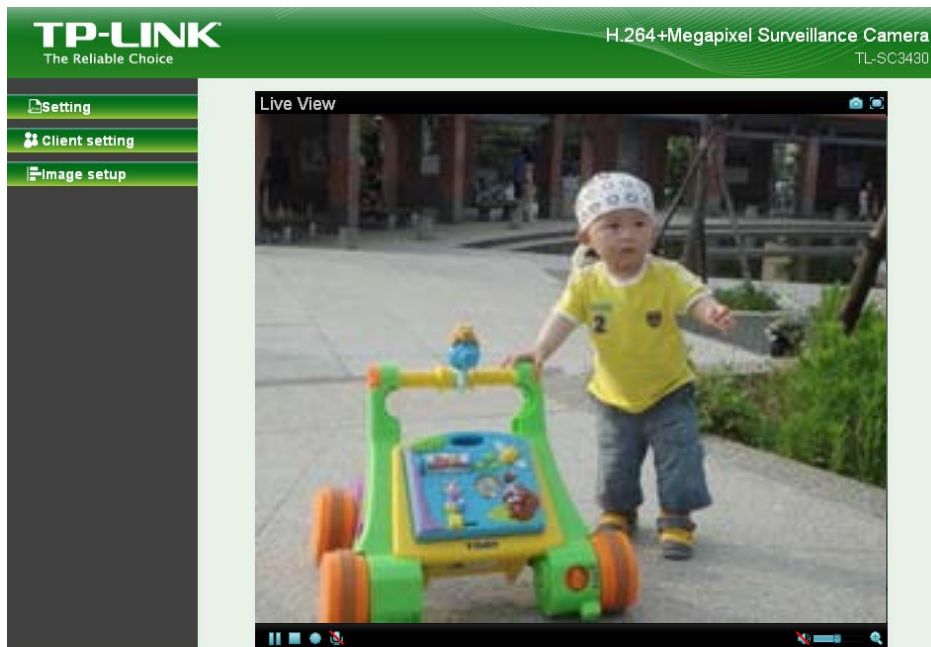

### 3.3 Mac Web Browser

- 1 Click the Safari icon, and enter the IP address of the IP camera in the Location / Address field of your browser.

**Note:**

If you only want to view the video without accessing Setting screen, enter “http://<IP>/index2.htm” as your web URL.





2 Enter the default account “admin” and default password “admin”.





**Note:**

The default user name “admin” and the password are set at the factory for the administrator. You can change them in the Account Menu (Please check “**Setting** → **Basic** → **Security** → **Account**”)

- 3 The monitor image will be displayed in your browser. In the far left side of main configuration are **Setting**, **Client Setting**, and **Image Setup**. For more details, you can check Chapter 6.2、 Chapter 6.3、 Chapter 6.4 and Chapter 6.5.

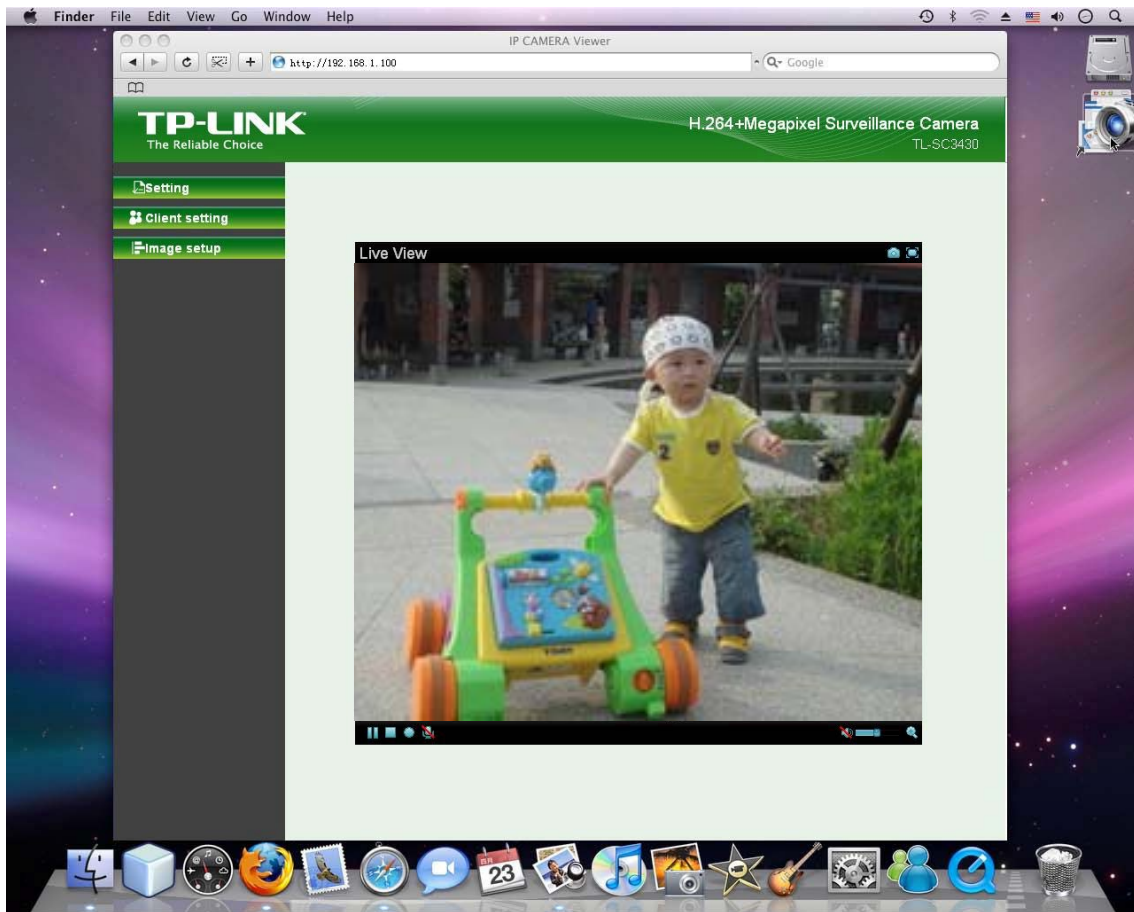

## Chapter 4 Operating IP Camera via Mobile Phone

### 4.1 Mobile Phone Viewing

#### 4.1.1 3G Mobile Phone Streaming Viewing

For 3G mobile phone viewing, type “**rtsp://<IP>:<PORT>/video.3gp**” into your 3G Streaming Link. <IP> is the Public IP address of your IP camera; <PORT> is the RTSP port of your IP camera (Default value is 554.) Example: `rtsp://100.10.10.1:554/video.3gp`

 **Note:**

You can also use RTSP clients (RealPlayer, VLC, QuickTime Player...etc.) to view RTSP streaming, just type in “**rtsp://<IP>:<PORT>/video.3gp**” as the Player URL.

#### 4.1.2 2.5G Mobile Phone WAP Viewing

For 2.5G mobile phone viewing, type “**http://<IP>/mobile.wml**” into your 2.5G WAP Browser. <IP> is the Public IP address of your IP camera.

#### 4.1.3 2.5G Mobile Phone Browser Viewing

For 2.5G mobile phone viewing, type “**http://<IP>/mobile.htm**” into your 2.5G Web Browser. <IP> is the Public IP address of your IP camera.

## 4.2 Using IP Camera via iPhone

You can use TP-LINK Web User Interface via iPhone. Please follow the setting process below. Then you can use TP-LINK Web UI via iPhone.

### 1. Select Safari function

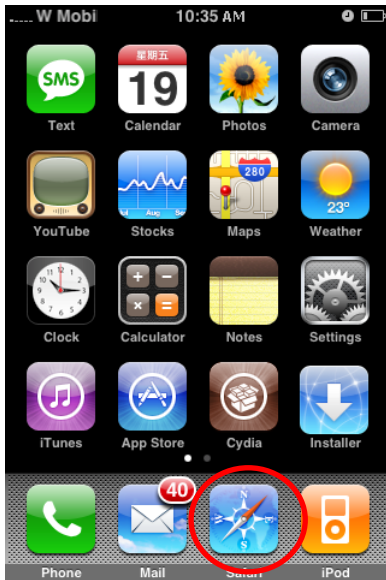

### 2. Enter IP address in your web link.



### 3. Enter name and password. Default values are both admin. Then click Log in

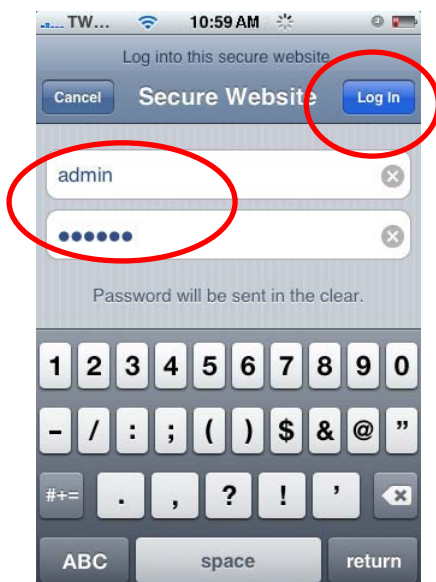

### 4. The TP-LINK User Interface and live image will show up in the middle of the screen.



**Note:** It will show continuous snapshots not a real time video streaming. Therefore, the recording feature is disabled.

## Chapter 5 MSN Messenger (Supports up to Windows Live Messenger version 8089)

Please see the following steps to set up the Messenger function.

1. **Application of a new MSN account:** You can download MSN software freely and create a new MSN account (e.g. camera at home@msn.com) to use Microsoft Live Messenger.
2. **Login Account and Password:** Go to **Setting**→**Basic**→**Network**→**Messenger**, set the Messenger to “On”. Then, enter the new account (camera at home@msn.com) and password to login.

 **Note:** This account (eg. camera at home@msn.com) is not your commonly used MSN account but a new one applied for IP Camera.

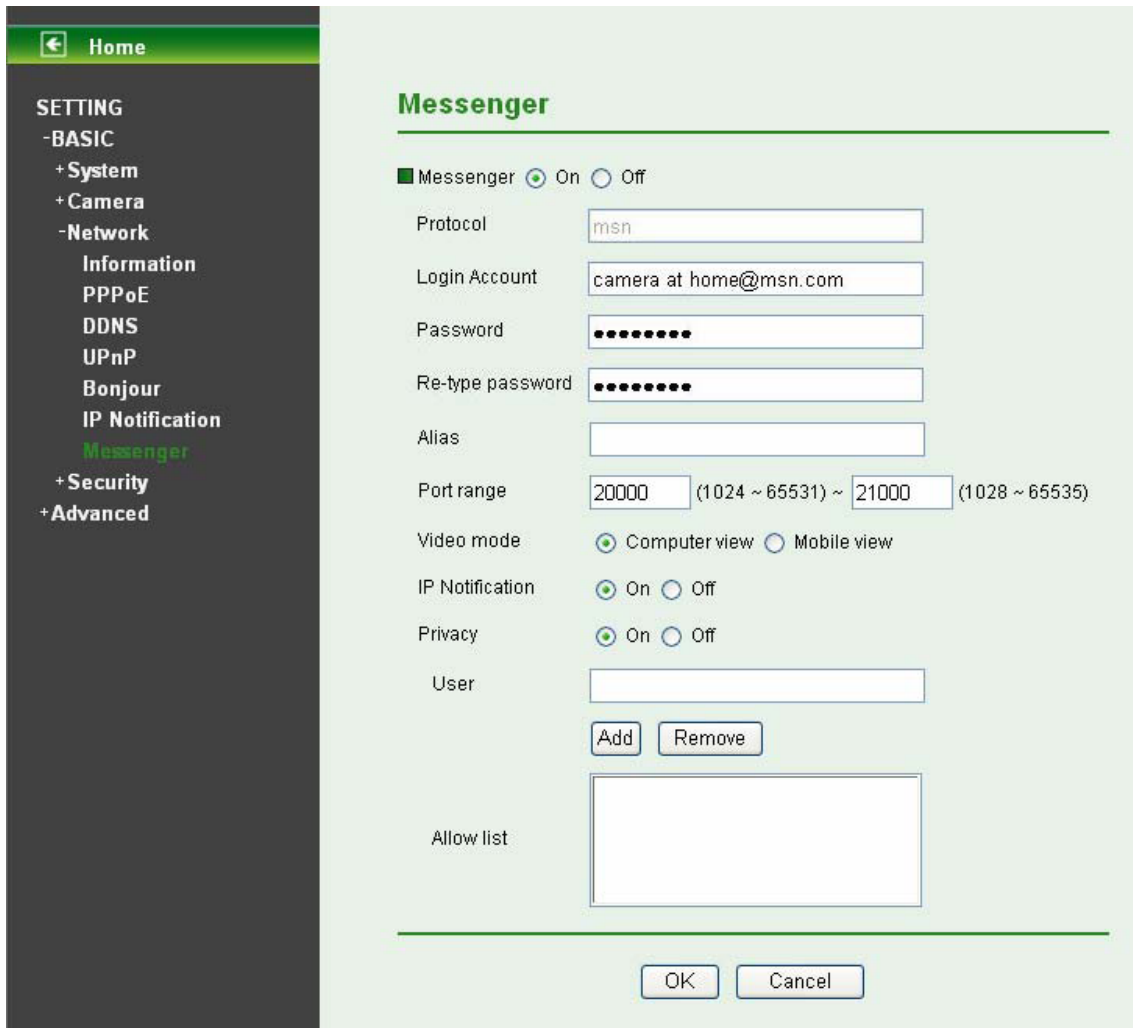

**Messenger**

Messenger  On  Off

Protocol:

Login Account:

Password:

Re-type password:

Alias:

Port range:  (1024 ~ 65531) ~  (1028 ~ 65535)

Video mode:  Computer view  Mobile view

IP Notification:  On  Off

Privacy:  On  Off

User:

Allow list:

3. **IP Notification:** Choose “On” at the option of IP Notification. If this feature switches On, camera will send IP notification to the users who are allowed.

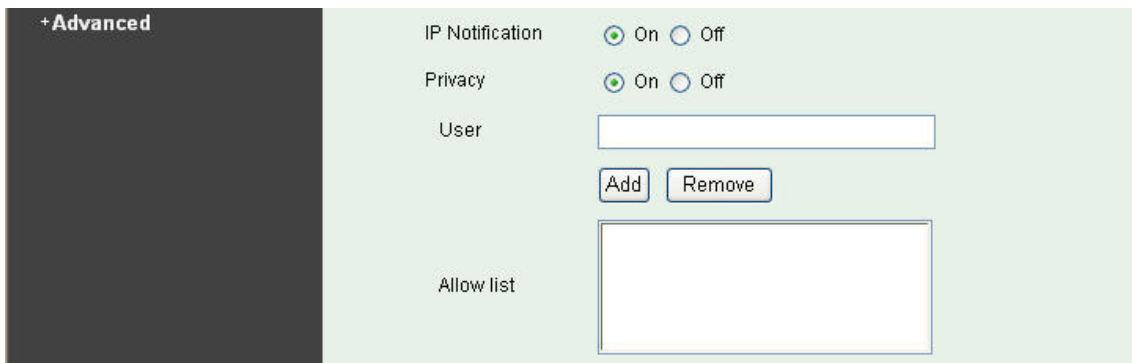

4. **Privacy & User & Allow List:** Choose “On” at the option of Privacy, then User column will appear and be able to build Allow List, so that only the users listed can access the camera via MSN.
5. **Log in Working Account:** Use your working account to login in the Messenger software. And add the camera’s MSN account (camera at home@msn.com) as a contact.

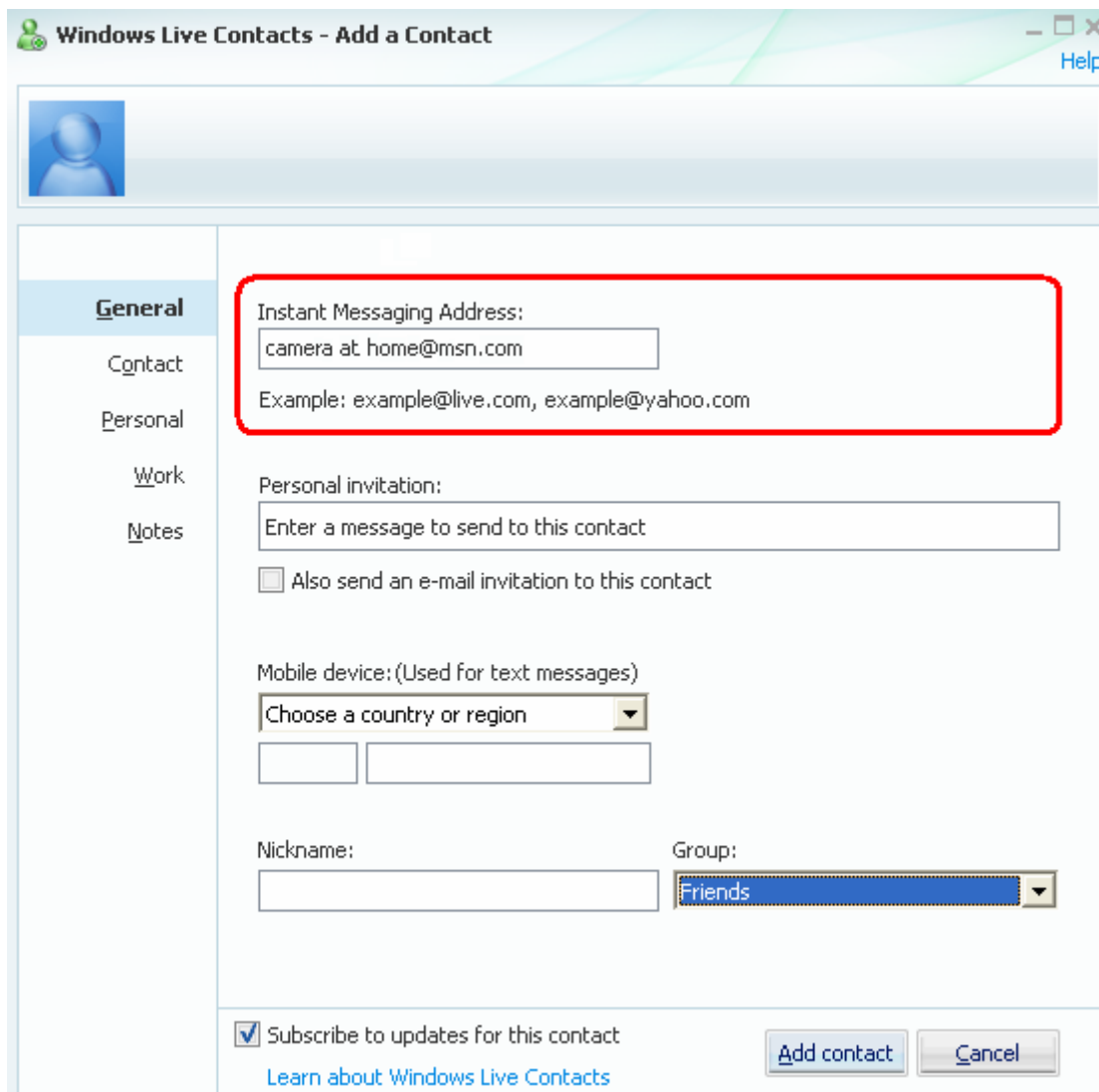

6. Check its status. Normally it should be online.

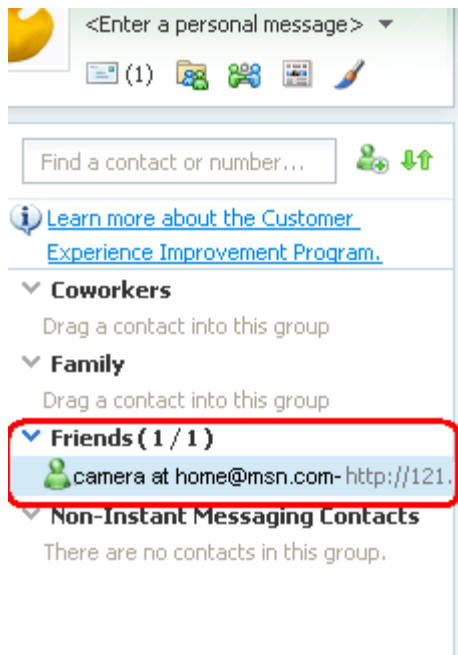

7. The **Camera at home** will show up with its Public IP and Private IP after sending a message of **"Ping"** in the lower key (if the option of IP Notification is "On").

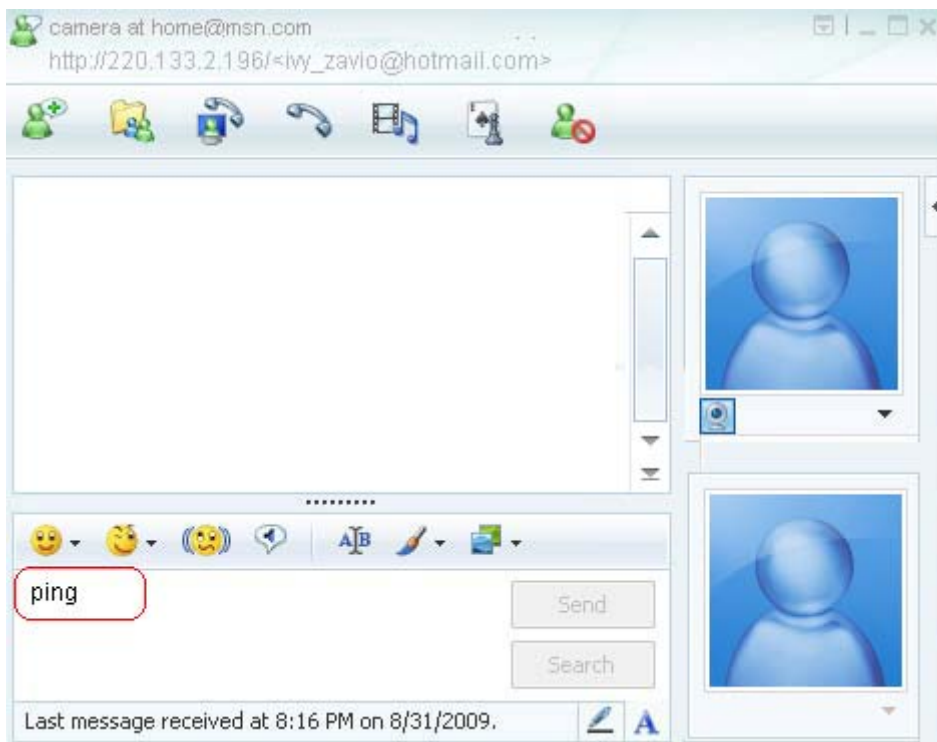

8. Click the camera icon  and select **View a contact's webcam** to view the video.

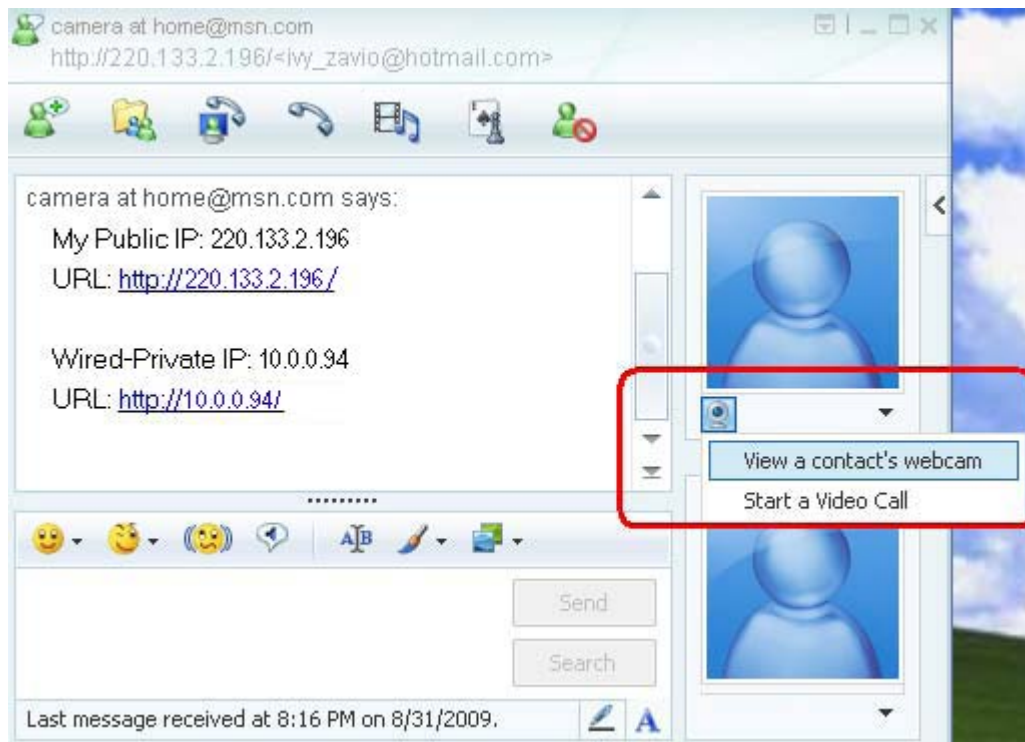

- The IP Camera will accept your invitation; the live video will show up in the right screen after few seconds.

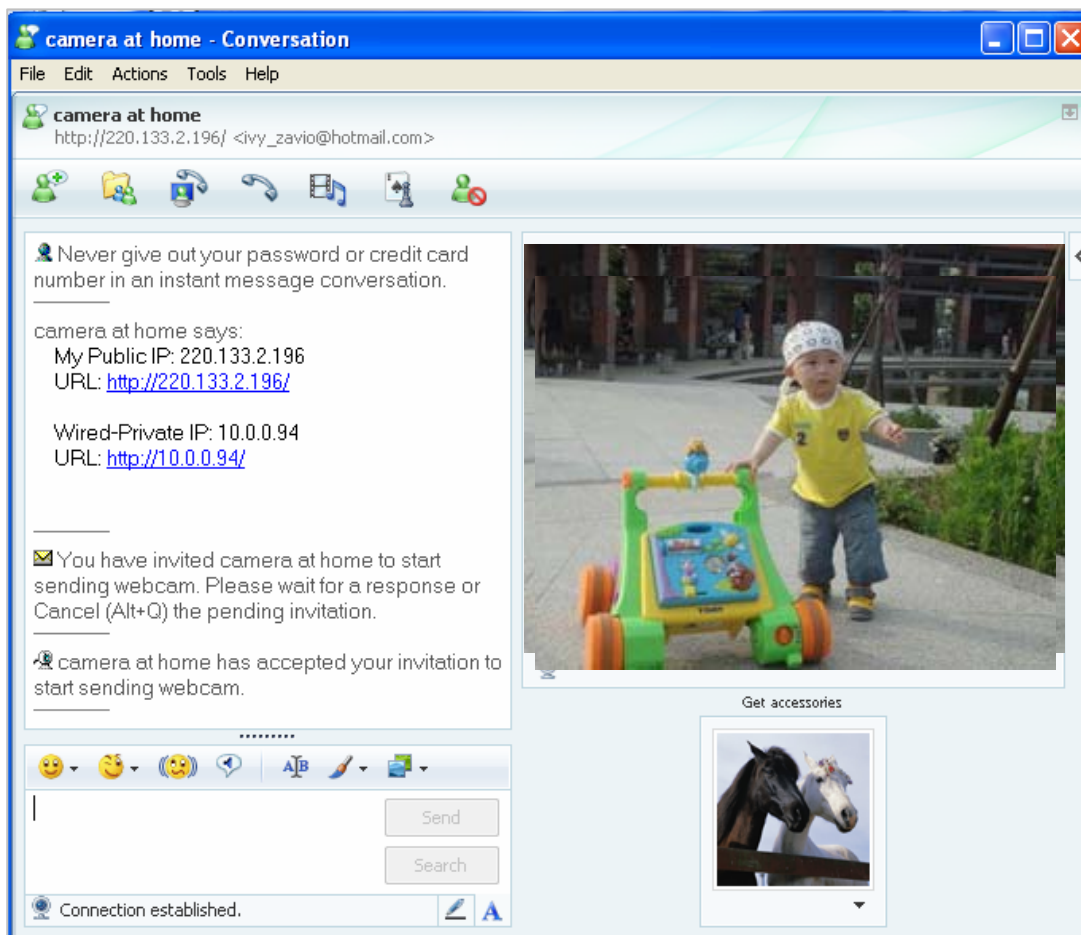

- Click **Action** button and choose **Start Control Panel** to use control panel.



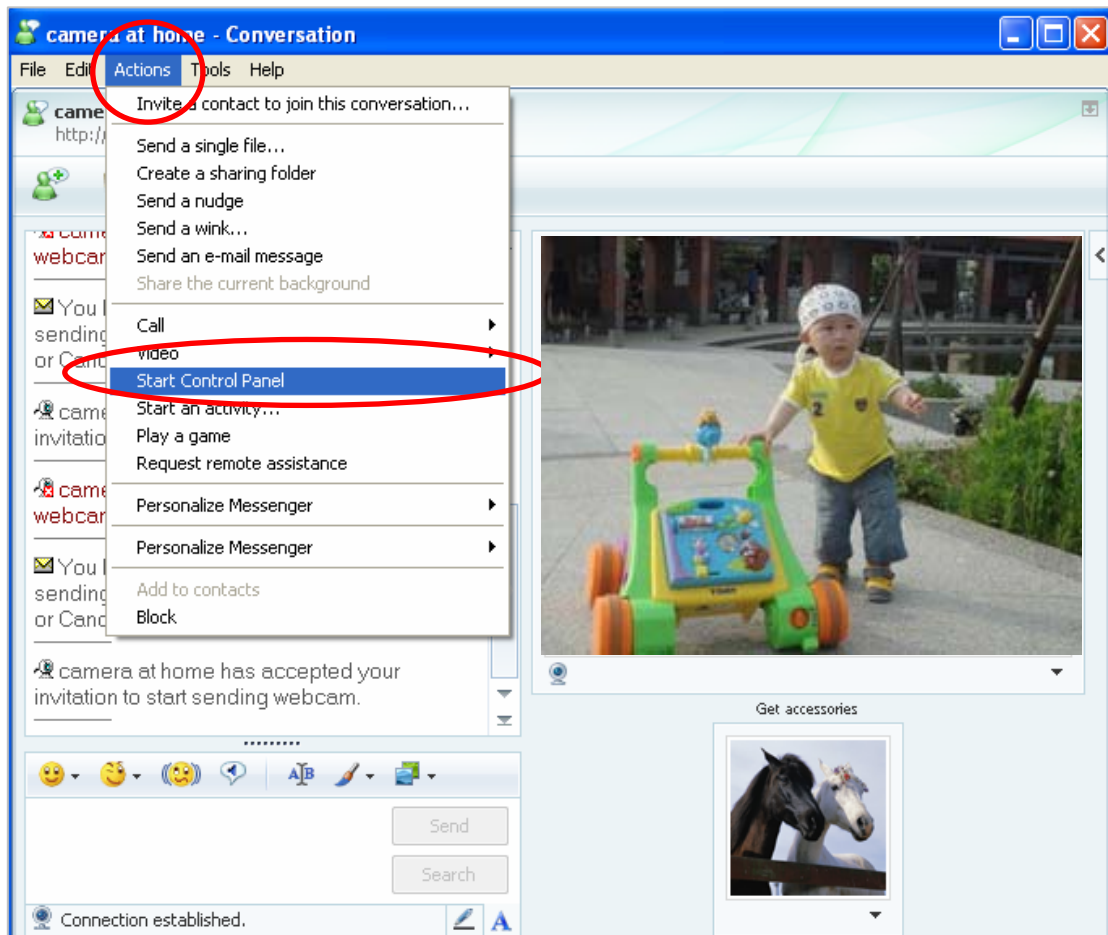

11. The dialog box will show up with “This application is not part of Windows Live Messenger.....” Tick the box of “Don’t show me this again” and click **OK**.

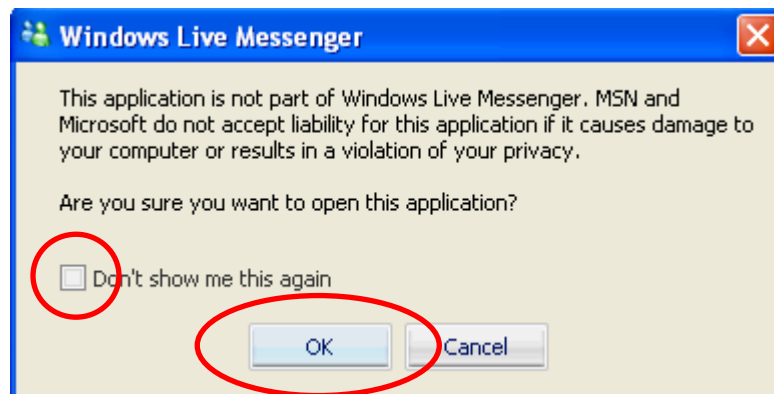



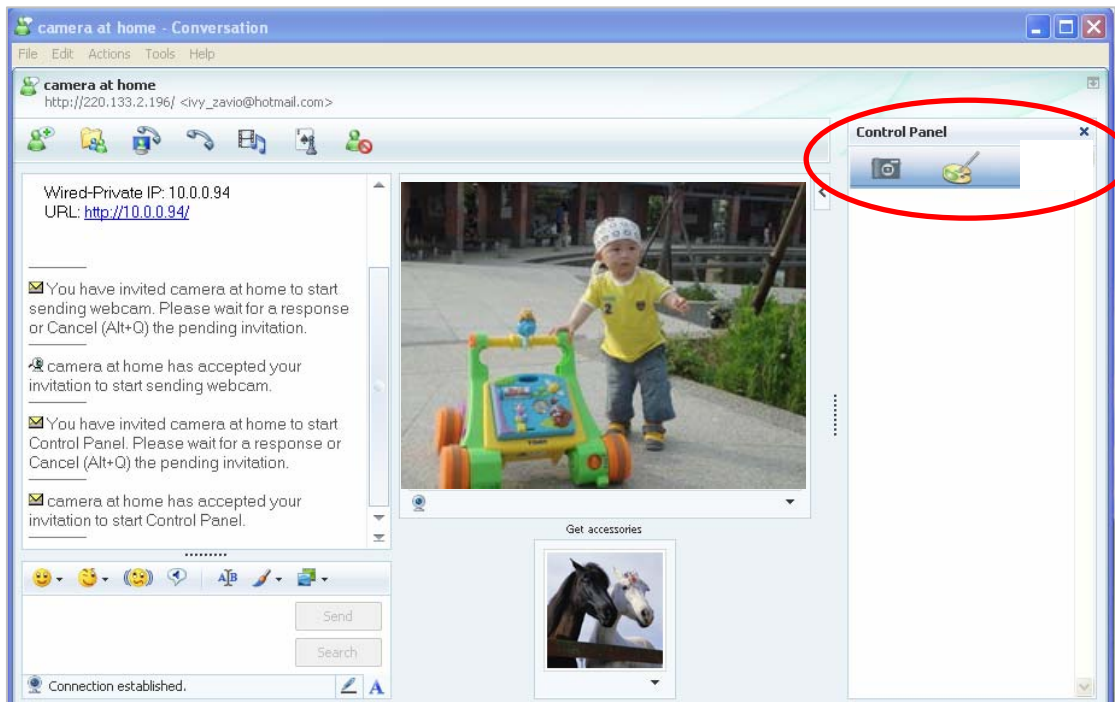

12. The IP Camera will accept your invitation to start Control Panel.



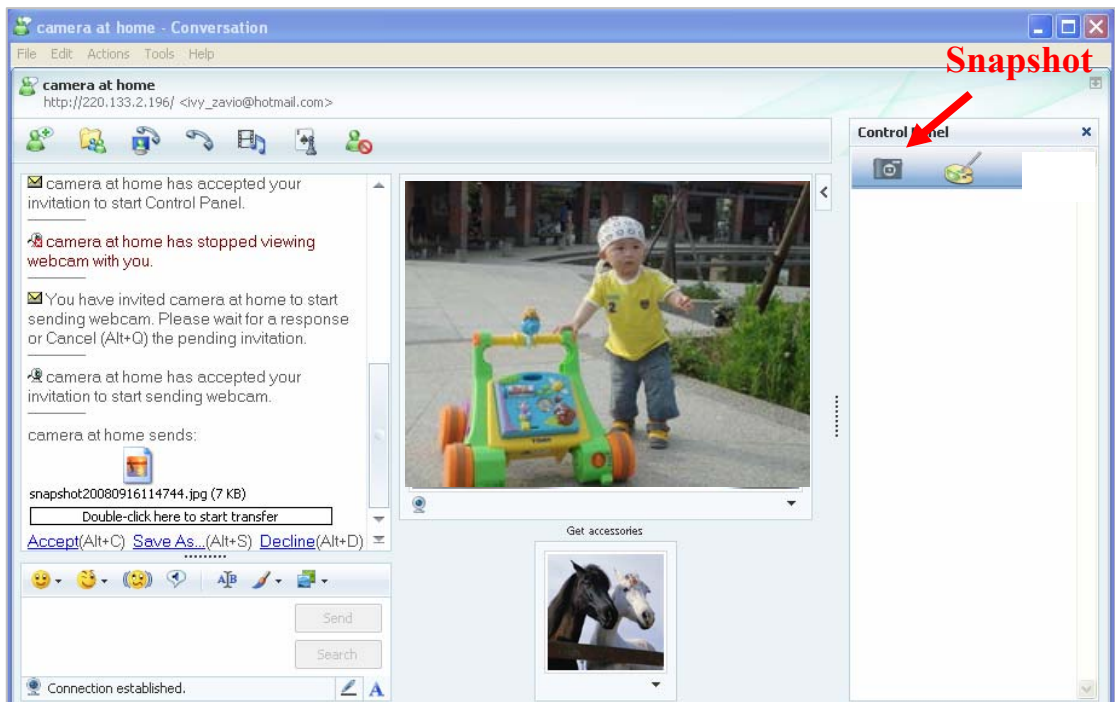

13. You can click Camera icon  to snapshot then the picture will send to you immediately.

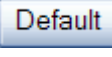

14. You can click paint palette icon  showing up with tool bar to set up image. Then, you can use the tool bar to optimize video Brightness , Contrast , Saturation  and Hue . After the adjustment of all setting, you can still click  to make the setting back to the original setting.

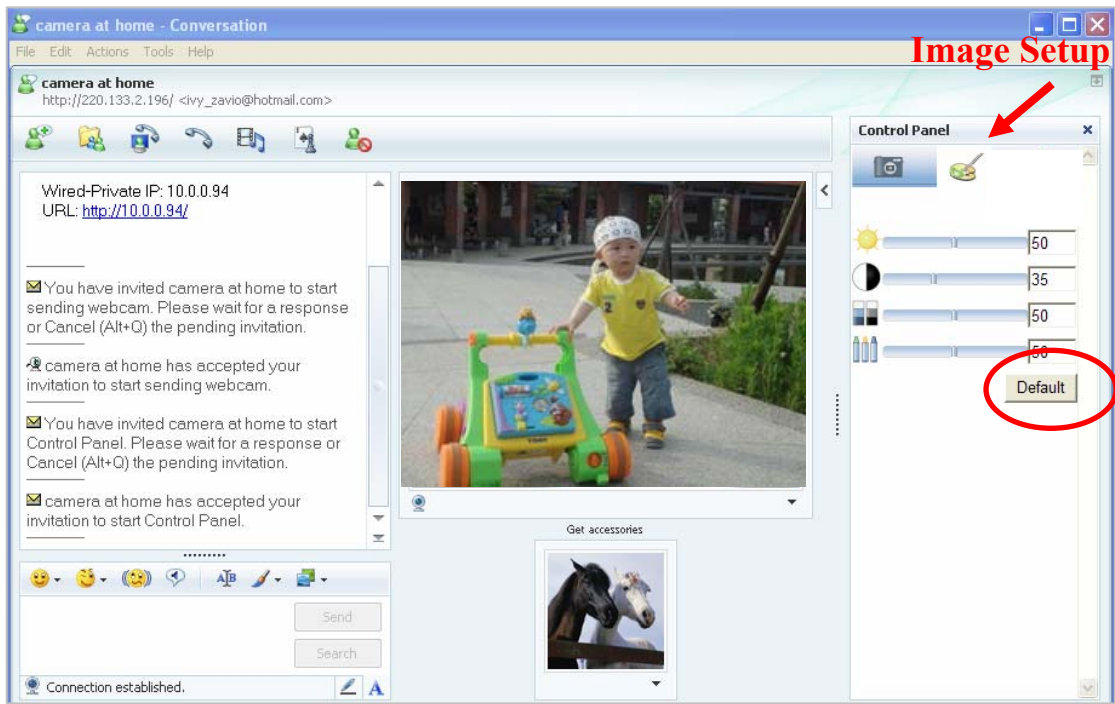

## Chapter 6 Configuration of Main Menu

In the left side of main configuration are Setting, Client setting, Image setting. For more details, please check Chapter 6.2、 Chapter 6.3、 Chapter 6.4.、 Chapter 6.5.

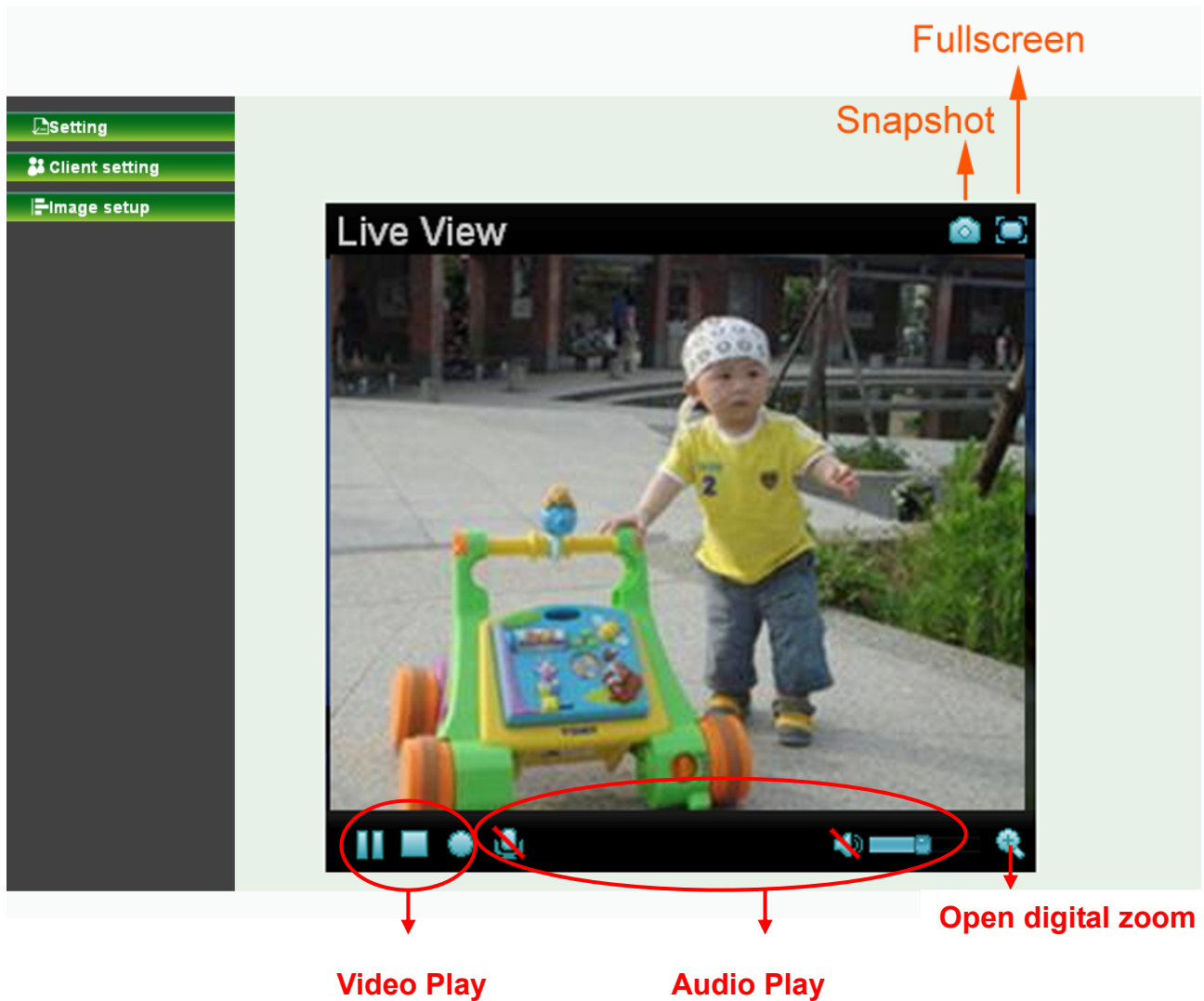

In the right side, you can control Live View in your main Browser. The functions include: **Snapshot**, **Open digital zoom**, **Audio**, and **Video Play**.



### 6.1 Live View



#### 6.1.1 Snapshot

You can capture a still image shot by clicking the camera icon and save it in the operating computer.





Symbols	Meaning
	a snapshot window appears after clicking the icon
<b>Save</b>	Save the picture captured by snapshot into your computer
<b>Close</b>	Return to the view screen
	full Screen

### 6.1.2 Digital zoom in / out the image via the monitor window



- Click  to display the digital zoom in window.
- Pull the  to adjust the digital zoom range, and it will be showed on the above window.
- Use the left click of your mouse to move  to anywhere in the window area.



### 6.1.3 Video play buttons



Symbols	Meaning
	Pause the current video
	Play the video
	Stop the current video
	Record the current video

 **Note:**

Concerning the recording storage requirement of your hard disk, please refer to the **CHAPTER 9. APPENDIX / B. Storage Requirement Table.**

### 6.1.4 Audio buttons

Symbols	Meaning	Note
	Speakers turned on	mean the speakers of your computer are turned on to transmit the sounds from the connected IP camera(s)
	Speakers turned off	mean the speakers of your computer are turned off to transmit the sounds from the connected IP camera(s)

	Mute off	mean you can broadcast to the connected IP camera(s) via the Ethernet using your microphone
	Mute on	mean you can't broadcast to the connected IP camera(s) via the Ethernet using your microphone
	Volume control bar	mean you can adjust the sound volume by the control bar

## 6.2 Setting

This function is only for the Administrator. Click “Setting” on the home page of web user interface to get into the **Basic** and **Advanced Settings** menu.

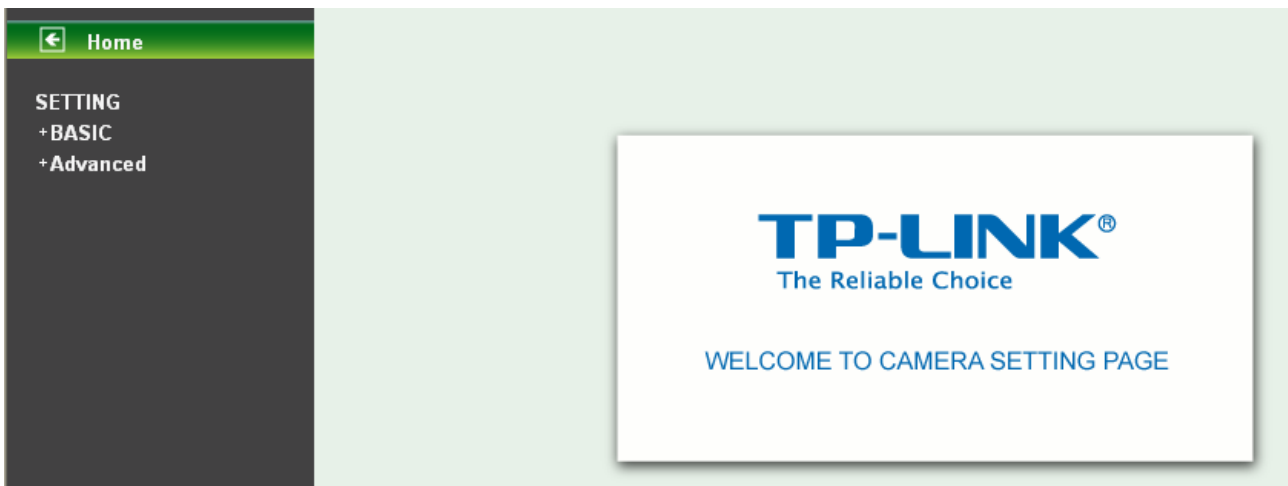

Click **Basic** folder, there are sub-folders including **System, Camera, Network, and Security**. For more information, you can see Chapter 7.1、 Chapter 7.2、 Chapter 7.3 and Chapter 7.4.

Click **Advanced** folder, there are sub-folders including FTP Client, SMTP, Network Storage, Schedule, Alarm Buffer, Motion Detection, Audio Detection, and System Log. For more information, please see Chapter 9.

## 6.3 Client Setting

This function is only for the client. Click this button to control **Mode**, **View Size**, **Protocol**, and **Video Buffer**.

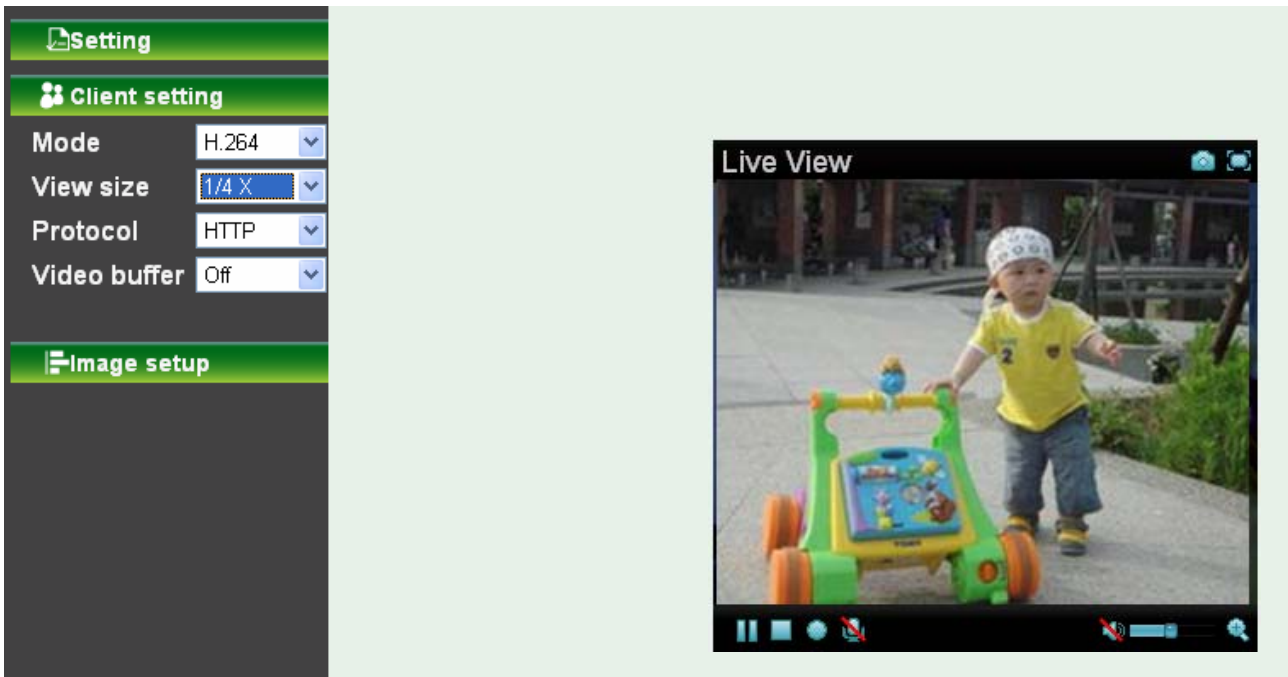

### 6.3.1 Mode

Click the pull-down box to choose video compression mode of **LIVE VIEW** among H.264, MPEG-4, and MJPEG.

 **Note:**

As long as the operating system not able to afford loading under H.264 mode, please downgrade the mode to MPEG-4 or MJPEG.

### 6.3.2 View Size

Select the desired view size of image resolution among 1/4X, 1/2X, and 1X.

### 6.3.3 Protocol

Select the transferring protocol among TCP, UDP, and HTTP.

### 6.3.4 Video Buffer

Turn the Video Buffer function On / Off. The Video Buffer function makes the streaming more smooth in unsteady network environment, but might cause a little delay in live viewing.



## 6.4 Image Setup

The tool bar can be adjusted to optimize video **Brightness, Contrast, Saturation** and **Sharpness**.



### 6.4.1 Brightness

The value range is 0~99. The higher value the brightness is, the brighter the image is.

### 6.4.2 Contrast

The value range is 0~99. The contrast is a measure of a display system, defined as the ratio of white to black that the system is capable of producing. The higher value the contrast is, the more delicate of color you can have.

### 6.4.3 Saturation

The value range is 0~99. The saturation of a color is determined by a combination of light intensity and how much it is distributed across the spectrum of different wavelengths. The higher value the saturation is, the more colorful the image will be.

### 6.4.4 Sharpness

The value range is 0~99. It applies image processing techniques to adjust the sharpness of live view. However, higher the value is, more the noise is.

### 6.4.5 Default

After the adjustment of all setting, you can still click Default to make the setting back to the original setting.

## Chapter 7 Setting-Basic

Click the **Basic** folder to display the sub folders including **System, Camera, Network, and Security.**

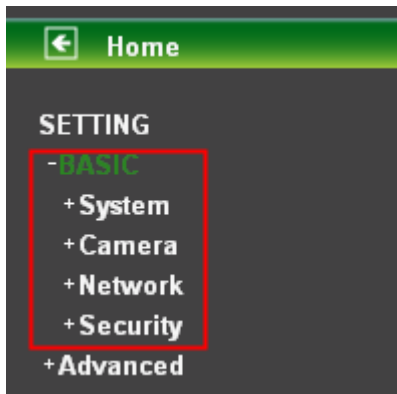

### 7.1 System

Click the folder of System to display the sub-folders including **Information, Date / Time, Initialize, and Language.**

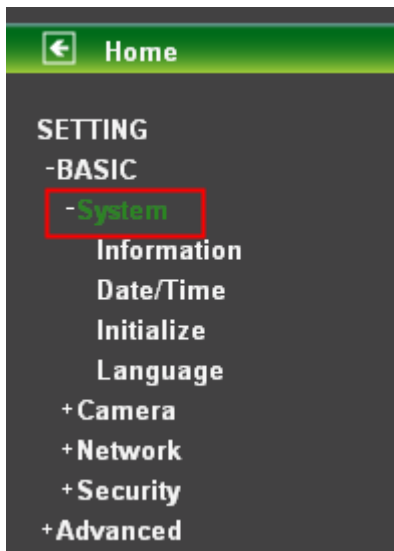

#### 7.1.1 Information

The Information screen provides the product factory information which includes **Product Name, Firmware Version.**



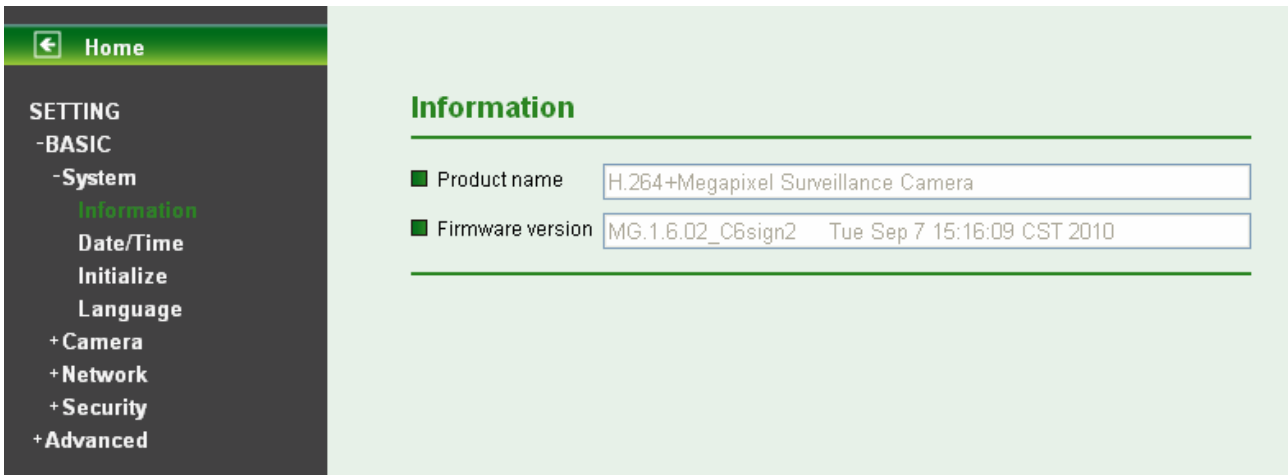

## 7.1.2 Date / Time

The Date/ Time screen displays all options of time setting.

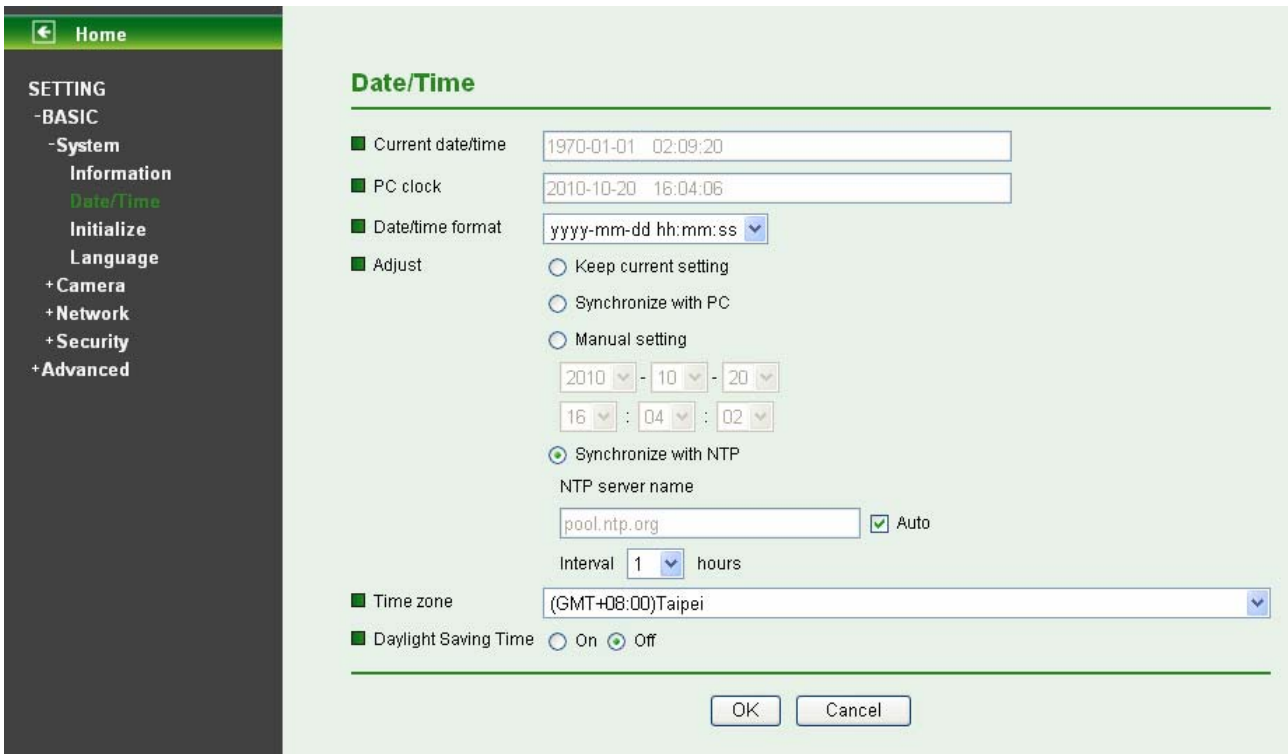

- **Current Date / Time:** This displays the current date and time of this IP Camera.
- **PC Clock:** This displays the date and time of the monitoring PC clock.
- **Date / Time Format:** You can click the pull down box to select different time display formats.

### Note:

If you would like the Date / Time information shows on the Live View screen, please check “**Setting** → **Basic** → **Camera** → **General** → **Date / Time**” to execute the setting.

- **Adjust:** You can select one of those four adjusting modes for your IP Camera.
  - **Keep current setting:** Select this mode to keep the current date and time of this IP Camera.
  - **Synchronize:** Select this mode to keep the date and time of this IP Camera is the same as the monitoring PC.
  - **Manual setting:** Select this mode to adjust manually the date and time of this IP Camera.

- **Synchronize with NTP:** Specify the NTP server name and the Refresh Interval to synchronize the date and time of this IP Camera with those of the time server, known as the NTP server.
- **Time Zone:** Select the Time Zone format of Greenwich Mean Time among different cities. The time display will be the same as the current date / time option.
- **Daylight Saving Time:** There are two modes to choose for setting up daylight saving time.
  - **By Date:** Set the start and end time by select month, day, hour, and minute.
  - **By Week Number:** Set the start and end time by select month, week, hour, and minute.

 **Note:**

The NTP server (Network Time Protocol) is the time server which is an Internet standard protocol built on the top of TCP / IP. This assures accurate synchronization to the millisecond of computer clock times in a network of computers.

### 7.1.3 Initialize

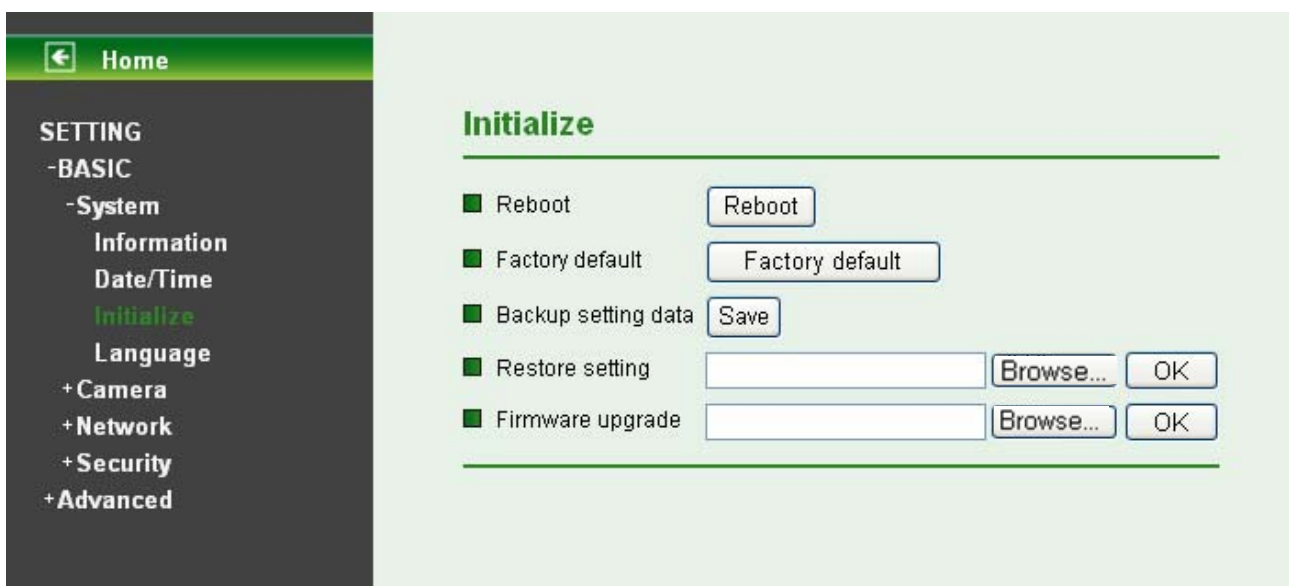

- **Reboot:** Click this button to reboot this IP Camera. A confirmation dialogue will appear and then click “OK” to execute. It takes one minute to complete the reboot process.
- **Factory Default:** Click this button to recover this IP Camera to the factory default setting. A confirmation dialogue will appear and then click “OK” to execute. The network indicator on this IP Camera will start to blink. This IP Camera will reboot automatically after completing adjustments to the default setting. Don't turn off this IP Camera until the device reboots.
- **Backup Setting:** You can save the setting data of this IP Camera into a file. Click “Save” and follow the instructions on the browser to save the setting data file to the location you specified.
- **Restore Setting:** Download the saved setting data of this IP Camera. Click “Browse” and select saved file. Click “OK” and this IP Camera is adjusted according to the loaded data and then restarted.
- **Firmware Update:** Update the device software. Click “Browse” and select the file for updating. A confirmation dialogue will appear. Click “OK” to start. This IP Camera will reboot upon completion.

 **Note:**

When updating the firmware version, please use the file specific for the model. Otherwise, some problems may occur. Unless the updating completed, please don't turn off the power or disconnect the network.

## 7.1.4 Language

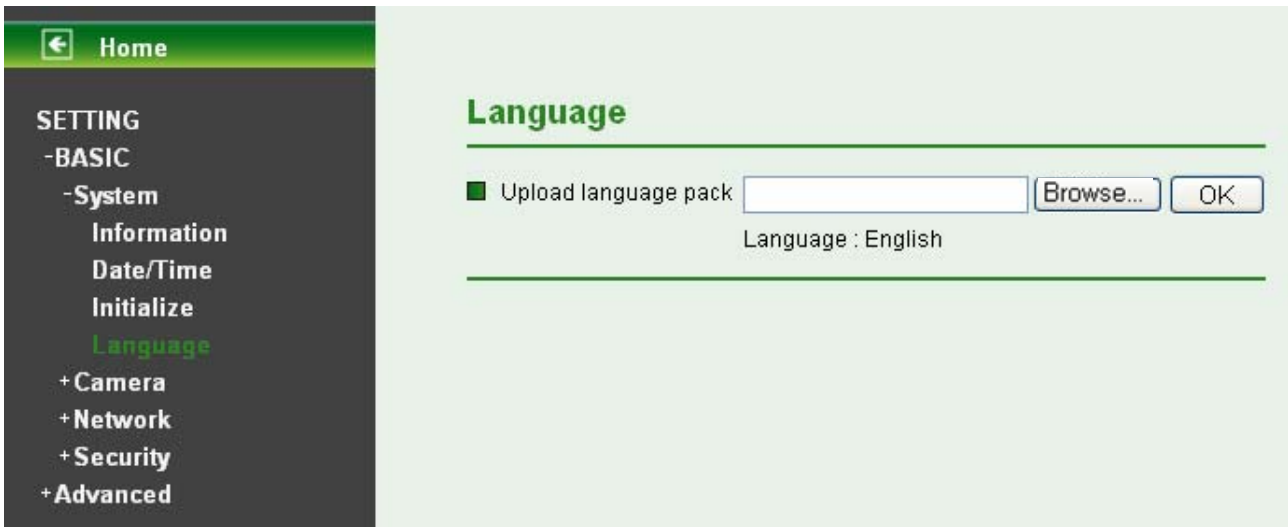

- **Upload Language Pack:** Clicking “Browse” and selecting the file for updating, the present language display of WEB User Interface could be changed. A confirmation dialogue will appear. Click “OK”, then the update will be applied immediately. The default language is “English.”

## 7.2 Camera

Click the folder of Camera to display the sub folders including **General, H.264, MPEG4, MJPEG, 3GPP, Advanced** and **Playback**.

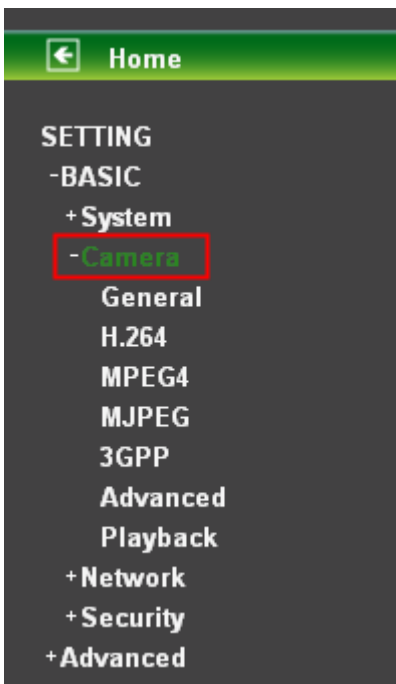

## 7.2.1 General

The screenshot shows the 'General' settings page. The sidebar on the left lists settings categories: SETTING, -BASIC, +System, -Camera, General (highlighted), H.264, MPEG4, MJPEG, 3GPP, Advanced, Playback, +Network, +Security, and +Advanced. The main content area is titled 'General' and includes the following settings:

- RTSP**:  RTSP port  554  [ ] (1024 ~ 65535)
- RTP**:  RTP  
Unicast streaming  
Port range  (1024 ~ 65532) ~  (1027 ~ 65535)
- Image rotated**:  Image rotated
- Audio Codec**:  Audio Codec
- Audio mode**:  Audio mode  Full duplex  Half duplex
- Bit rate**:  Bit rate
- Video clip format**:  Video clip format
- Text overlay**:  Text overlay  On  Off
- Privacy mask**:  Privacy mask  On  Off

Buttons: OK, Cancel

- **RTSP**: The default value is 554. If the IP Cameras connected with router and installed outside are over 2 sets and all of them need support RTSP, please fill some value in the blank space in the range from 1024 to 65535.
- **RTP Unicast Streaming**: The default value of port range is 5000 ~ 7999 and can be changed from 1024 to 65535.

### Note:

Under Unicast streaming mode, streaming video is delivered from the camera to a single client device.

- **Image Rotated**: Select the screen display “flip”, “mirror”, or “flip + mirror.”
- **Audio Codec**: Select one audio codec among G.711 U-law / G.711 A-law / AMR Audio / Off.
  - **G.711 U-law**: one codec for “Computer Audio”, used in North America & Japan areas.
  - **G.711 A-law**: another codec for “Computer Audio”, used in Europe and the rest of the world.
  - **AMR Audio**: an audio codec of the third generation communication for MOBIL
  - **PHONE**. While the option selected, your mobile phone will receive the audio file from IP Camera. And you can choose the bit rate from 4.75k to 12.2k. However, the usage of this codec will cause frame-rate decreasing.
  - **Off**: Select Off, audio file won’t be transmitted by IP CAM.
- **Audio Mode**: You can select Full duplex or Half duplex.
  - **Full duplex**: Select it for simultaneous communication in both direction between the connected administrator and IP CAM. It means both parties can speak and be heard at the same time.
  - **Half duplex**: Select it for communication in both directions, but only one direction at a time (not simultaneously). It means one party begins receiving a signal, it must wait for the transmitter to stop transmitting, before replying. Therefore, once one party speak, he can’t hear any voice from the other party, just like the communication by radio set.
- **Video Clip Format**: Select RECORDING compression format H.264 or MPEG-4.
  - **MPEG-4**: MPEG-4 has the advantage of sending a lower volume of data per time unit across the network (bit-rate) compared to Motion JPEG and therefore provides a relatively high image quality at a lower bit-rate (bandwidth usage).

- **H.264:** H.264 provides higher compression rate than MPEG-4. Thus, H.264 can decrease the bandwidth usage and further apply on 3G. However, H.264 will occupy more system resources than MPEG-4. As long as the operating system appears operating difficulties under H.264 format, please change to select MPEG-4.
- **Text Overlay:** Some information can be showed on the display screen, such as Date / Time and user-defined text. And the background color can be chosen.
- **Privacy Mask:** A specific area of the video image can be covered.

## 7.2.2 H.264

The screenshot shows the H.264 configuration screen. On the left is a dark sidebar with a 'Home' button at the top and a menu containing: SETTING, -BASIC, + System, -Camera, General, H.264 (highlighted), MPEG4, MJPEG, 3GPP, Advanced, Playback, + Network, + Security, and + Advanced. The main area is light green and titled 'H.264'. It contains the following settings:

- Viewer authentication  On  Off
- Multicast streaming  On  Off
- Multicast address:
- Video port:  Auto   (1024 ~ 65534)
- Audio port:  Auto   (1024 ~ 65534)
- Time-To-Live:  (1 to 255)
- Image Size:  ▾
- Frame rate:  ▾ fps
- Quality:
  - Auto
  - Fixed quality:  ▾
  - Fixed bitrate:  ▾ bps
- IP interval:  ▾

At the bottom are 'OK' and 'Cancel' buttons.

- **Viewer Authentication:**
  - **On:** If the viewer authentication is On, the users will be requested to key-in username and password when using QuickTime Player to have live viewing.
  - **Off:** If the viewer authentication is Off, you can have live viewing on computer by QuickTime Player after entering "rtsp://ip:port/video.h264" on the URL column directly.
- **Multicasting Streaming (if it's on):**
  - **Multicast Address:** The multicast server address will appear automatically.
  - **Video / Audio Port:** Specify the transmission port number of the video data, from 1024 to 65535.
  - **Time to Live:** Set the maximum TTL that multicast can pass through.

 **Note:** Time To Live option determines the maximum length of time (measure as the number of

network routers that can be passed before data arrives at its destination or is dropped) within which a multicast packet must reach its destination.

- **Image Size:** Specify the image size when the network camera transmits. Choose one among 1280 x 1024, 1280 x 720, 640 x 480, and 320 x 240.
- **Frame Rate:** Set the frame rate of H.264 image. Choose one value among 2, 3, 4, 5, 7, 10, 15, 20, 25, and 30 fps. The unit “fps” stands for “frames per second”.

 **Note:**

The frame rate is up to 15 fps at 1280x1024, and up to 30 fps at 640x480. However, if you would like choose frame rate over 15 fps, the IMAGE SIZE of H.264/MPEG-4/MJPEG setting page has to been selected 320x240 or 640x480 at the same time.

- **Quality:**
  - Auto: The quality and bitrate will be adjusted automatically according to the frame rate.
  - Fixed Quality: Select the value of quality among Medium, Good, Delicate and Excellent.
  - Fixed Bitrate: Set the bitrate of H.264 image transmission for a line. Select one among 64Kbps, 128Kbps, 256Kbps, 384Kbps, 512Kbps, 768Kbps, 1Mbps, 1.5 Mbps, 2 Mbps, 3 Mbps, 4 Mbps, 5 Mbps, and 6 Mbps.

 **Note:**

Concerning how to select the suitable image quality for Fixed Quality or Fixed Bitrate, please refer to the **CHAPTER 9. APPENDIX / A. Frame-rate & Bitrate Table**.

- **IP Interval:** It's the ratio of i-frame & p-frame. Select one among 1, 5, 10, 15, 30, 60, and 120. The ratio smaller, the streaming smoother.

 **Note:**

The IP interval value means a ratio of “ P-frame / I-frame “ in a certain section of frame sequences. The ratio lower, the live view clear. However, live view will lag if the bandwidth isn't big enough. In this situation, you have to choose another bigger IP interval value to solve the problem.

 **Note:**

If Video Clip Format of General Menu (go “**Setting** → **Basic** → **Camera** → **General**” ), which is for recording compression, is chosen H.264, the IP interval option will appear “Auto” automatically and can't select. The limit is for avoiding damaging the recording quality of 5 seconds temporary-saved video recorded on FTP server.

## 7.2.3 MPEG4

The screenshot shows the 'MPEG4' settings page. On the left is a navigation menu with 'MPEG4' selected. The main content area has the following settings:

- Viewer authentication:**  On  Off
- Multicast streaming:**  On  Off
- Multicast address:** 228.0.0.1
- Video port:**  Auto  [ ] (1024 ~ 65534)
- Audio port:**  Auto  [ ] (1024 ~ 65534)
- Time-To-Live:** 15 (1 to 255)
- Image Size:** 1280x1024
- Frame rate:** 15 fps
- Quality:**  Fixed quality: Excellent
- IP interval:** Auto

Buttons for 'OK' and 'Cancel' are at the bottom.

### ➤ **Viewer Authentication:**

- **On:** If the viewer authentication is On, the users will be requested to key-in username and password when using QuickTime Player to have live viewing.
- **Off:** If the viewer authentication is Off, you can have live viewing on computer by QuickTime Player after entering “rtsp://ip:port/video.mp4” on the URL column directly.

### ➤ **Multicasting Streaming** (if it's on):

- **Multicast Address:** Specify the multicast server address.
- **Video / Audio Port:** Specify the transmission port number of the video data, from 1024 to 65534.
- **Time to Live:** Set the maximum TTL that multicast can pass through.

### 👉 **Note:**

Time To Live option determines the maximum length of time (measure as the number of network routers that can be passed before data arrives at its destination or is dropped) within which a multicast packet must reach its destination.

- **Image Size:** Specify the image size when the network camera transmits. Choose one among 1280 x 1024, 1280 x 720, 640 x 480, and 320 x 240.
- **Frame Rate:** Set the frame rate of the MPEG-4 image. Choose one from 1, 2, 3, 4, 5, 7, 10, 15, 20, 25, and 30 fps. The unit “fps” stands for “frames per second.”



 **Note:**

The frame rate is up to 15 fps at 1280x1024, and up to 30 fps at 640x480. However, if you would like choose frame rate over 15 fps, the IMAGE SIZE of H.264/MPEG-4/MJPEG setting page has to been selected 320x240 or 640x480 at the same time.

➤ **Quality:**

- **Auto:** The quality and bitrate will be adjusted automatically according to the frame rate.
- **Fixed Quality:** Select the value of quality among Medium, Good, Delicate and Excellent.
- **Fixed Bitrate:** Set the bitrate of MPEG-4 image transmission for a line. You can select one value among 64Kbps, 128Kbps, 256Kbps, 384Kbps, 512Kbps, 768Kbps, 1Mbps, 1.5 Mbps, 2 Mbps, 3 Mbps, 4 Mbps, 5 Mbps, and 6 Mbps.

 **Note:**

Concerning how to select the suitable image quality for Fixed Quality or Fixed Bitrate, please refer to the CHAPTER 9. APPENDIX / A. Frame-rate & Bitrate Table.

- **IP interval:** It's the ratio of i-frame & p-frame. You can select one among 1, 5, 10, 15, 30, 60, and 120. The ratio smaller, the streaming smoother.

 **Note:**

The IP interval value means a ratio of “ P-frame / I-frame “ in a certain section of frame sequences. The ratio lower, the live view clear. However, live view will lag if the bandwidth isn't big enough. In this situation, you have to choose another bigger IP interval value to solve the problem.

 **Note:**

If Video clip format of General Menu, which is for recording compression, is chosen MPEG-4, the IP interval option will appear “Auto” automatically and can't select. The limit is for avoiding damaging the recording quality of 5 seconds temporary-saved video recorded on FTP server.



## 7.2.4 MJPEG

The screenshot shows a web interface for configuring MJPEG settings. On the left is a dark sidebar with a 'Home' button and a menu of settings categories: SETTING, -BASIC, +System, -Camera, General, H.264, MPEG4, MJPEG (highlighted), 3GPP, Advanced, Playback, +Network, +Security, and +Advanced. The main area is titled 'MJPEG' and contains the following settings:

- Viewer authentication:  On  Off
- Multicast streaming:  On  Off
- Multicast address:
- Video port:  Auto   (1024 ~ 65534)
- Audio port:  Auto   (1024 ~ 65534)
- Time-To-Live:  (1 to 255)
- Image Size:
- Frame rate:   fps
- Quality:  Auto  Fixed quality

At the bottom are 'OK' and 'Cancel' buttons.

- **Viewer Authentication:**
  - **On:** If the viewer authentication is On, the users will be requested to key-in username and password when using QuickTime Player to have live viewing.
  - **Off:** If the viewer authentication is Off, you can have live viewing on computer by QuickTime Player after entering "rtsp://ip:port/video.mjpg" on the URL column directly.
- **Multicasting streaming** (if it's on):
  - **Multicast Address:** Specify the multicast server address.
  - **Video / Audio Port:** Specify the transmission port number of the video data, from 1024 to 65535.
  - **Time to Live:** Set the maximum TTL that multicast can pass through.

### Note:

Time To Live option determines the maximum length of time (measure as the number of network routers that can be passed before data arrives at its destination or is dropped) within which a multicast packet must reach its destination.

- **Image Size:** Specify the image size when the network camera transmits. Choose among 1280 x 1024, 1280 x 720, 640 x 480, and 320 x 240.
- **Frame Rate:** Set the frame rate of the MJPEG image. Choose one among 1, 2, 3, 4, 5, 7, 10, 15, 20, 25, and 30 fps. The unit "fps" stands for "frames per second".

### Note:

The frame rate is up to 15 fps at 1280x1024, and up to 30 fps at 640x480. However, if you would like choose frame rate over 15 fps, the IMAGE SIZE of H.264/MPEG-4/MJPEG setting page has to been

selected 320x240 or 640x480 at the same time.

➤ **Quality:**

- **Auto:** The quality and bit rate will be adjusted automatically according to the frame rate.
- **Fixed Quality:** Select the value of quality among Medium, Good, Delicate and Excellent.
- **Fixed Bitrate:** Set the bitrate of MJPEG image transmission for a line. You can select one among 64Kbps, 128Kbps, 256Kbps, 384Kbps, 512Kbps, 768Kbps, 1Mbps, 1.5 Mbps, 2 Mbps, 3 Mbps, 4 Mbps, 5 Mbps, and 6 Mbps.

👉 **Note:**

Concerning how to select the suitable image quality for Fixed Quality or Fixed Bitrate, please refer to the **CHAPTER 9. APPENDIX / A. Frame-rate & Bitrate Table**.

## 7.2.5 3GPP

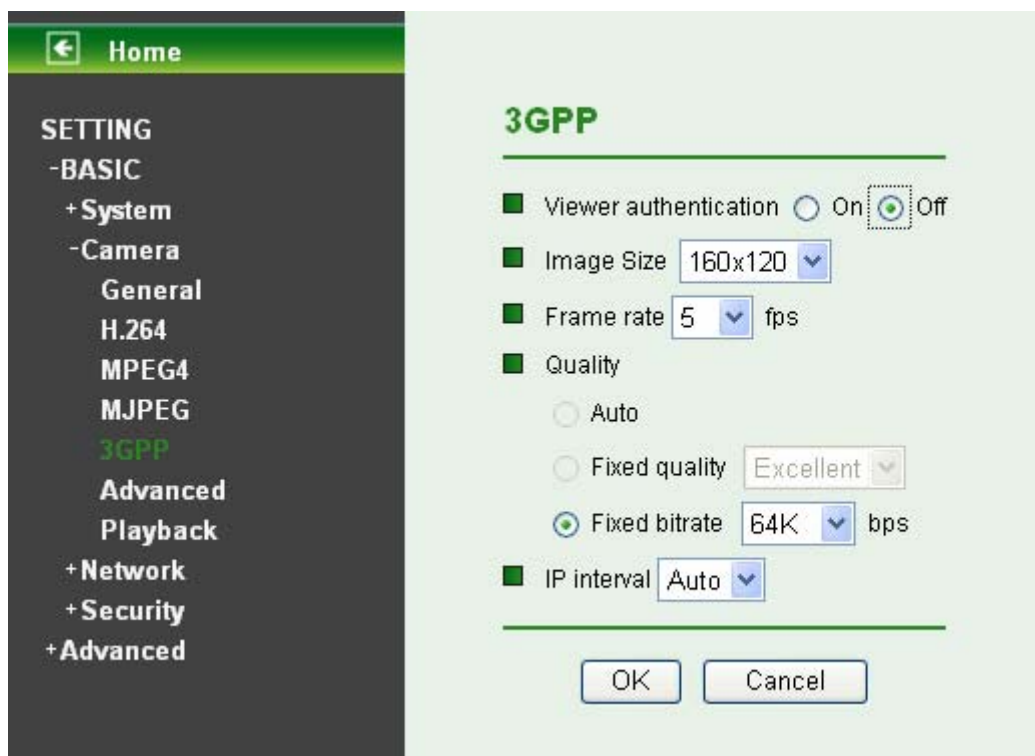

➤ **Viewer Authentication:**

- **On:** If the viewer authentication is On, the users will be requested to key-in username and password when using QuickTime Player to have live viewing.
- **Off:** If the viewer authentication is Off, you can have live viewing on computer by QuickTime Player after entering "rtsp://ip:port/video.3gp" on the URL column directly.

➤ **Image Size:** Image size for 3GPP is 320 x 240 or 160 x 120.

➤ **Frame Rate:** Set the frame rate of the 3GPP image. Choose one between 5 or 10 fps.

➤ **Quality:**

- **Auto:** The quality and bit rate will be adjusted automatically according to the frame rate.
- **Fixed Quality:** This item here can't be selected.
- **Fixed Bitrate:** Set the bitrate of 3GPP image transmission for a line. You can select one among 64Kbps, 48Kbps, 32Kbps, 16Kbps.

➤ **IP Interval:** It's the ratio of i-frame & p-frame. You can select one among 1, 5, 10, 15, 30, 60, and 120. The ratio smaller, the streaming smoother.

**Note:**

The IP interval value means a RATIO of “ P-frame / I-frame “ in a certain section of frame sequences. The ratio lower, the live view clear. However, live view will lag if the bandwidth isn't big enough. In this situation, you have to choose another bigger IP interval value to solve the problem.

## 7.2.6 Advanced

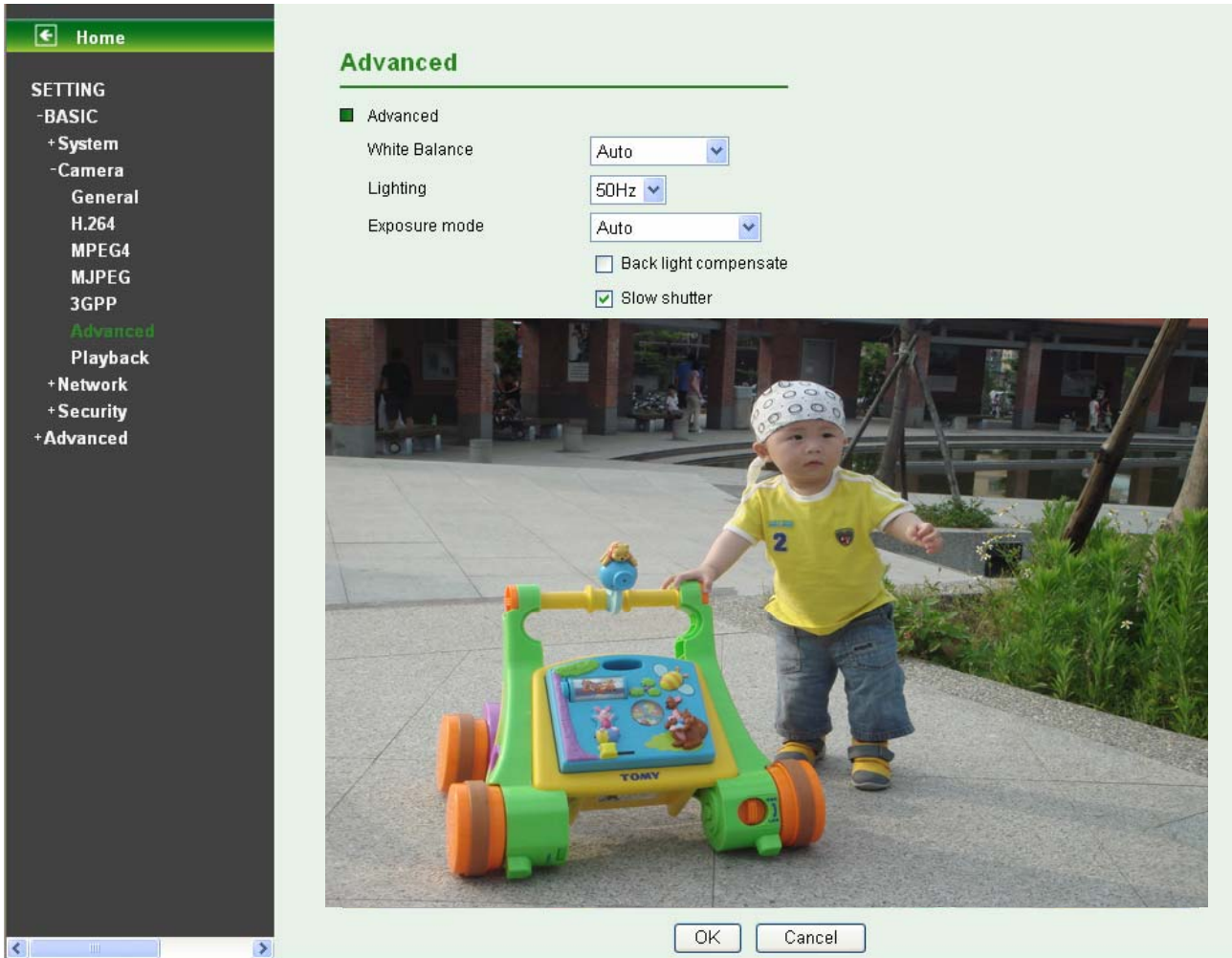

- **White Balance:** Choose the white balance among Auto, Florescent, Incandescent and Black & White.
- **Lighting:** The default setting of lighting environment is **Auto**. However, you may also choose 50 or 60 Hz upon the lighting environment of your country.
- **Exposure Mode:** Choose **Auto**, **High Speed Mode**, or **Manual** upon the capture environment.
  - **Auto:** Choose Auto and you have 3 options to adjust the exposure condition.
    - ✓ **Back Light Compensate:** Click it on and it helps avoid problems in situations where the main subject ends up being too dark, such as when shooting people or other subjects in front of a bright background.
    - ✓ **Slow Shutter:** Click it on and the range of shutter speed will be from 1/5 to 1/120 sec. It will adjust the shutter speed automatically and helpful to capture the clear image when shooting in a dark place.
  - **High Speed Mode:** Choose High Speed Mode and the shutter speed will be close 1/120 sec. as far as possible to help to capture the motion image of sports or high-speed phenomena.
  - **Manual:** Choose Manual and you can select options, including **Shutter Speed** and **Gain**.

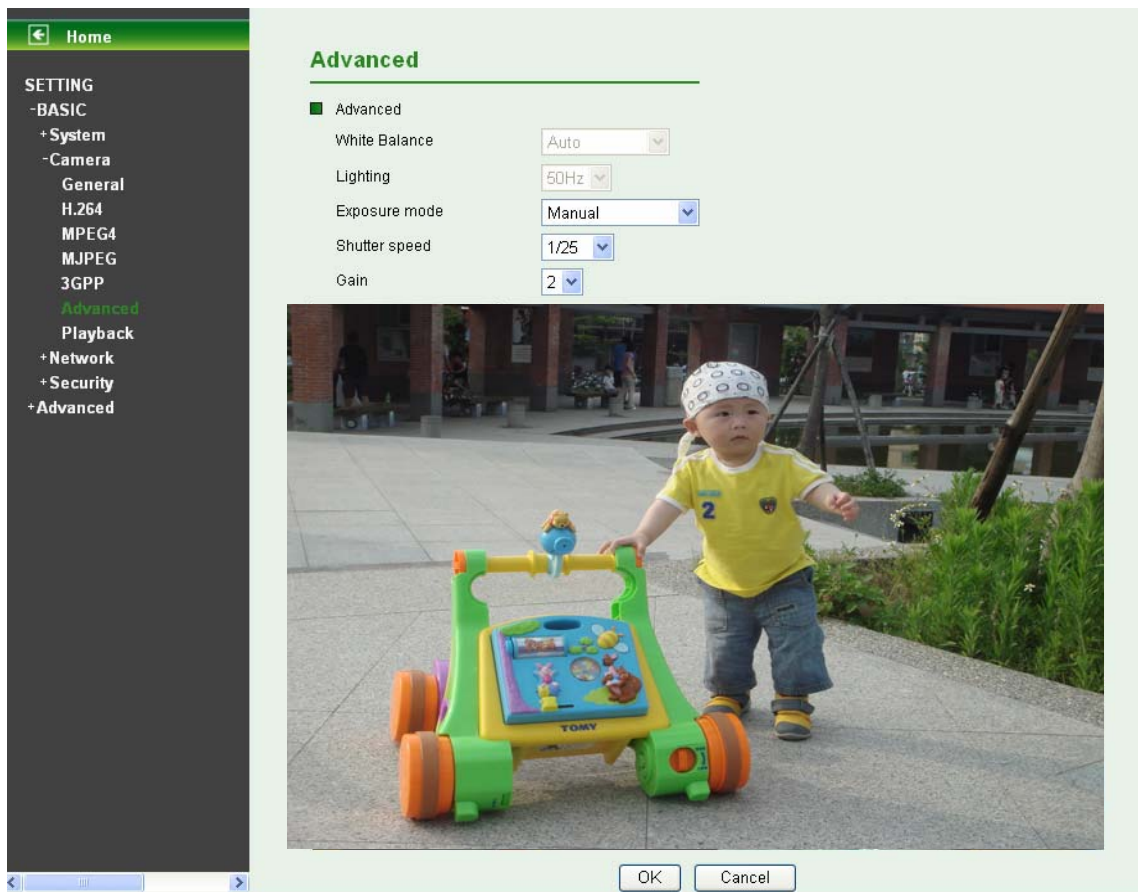

- ✓ **Shutter Speed:** The default value is 1/30 sec. and you can select the value among 1/4, 1/6, 1/12, 1/30, 1/60, and 1/120 sec.
- ✓ **Gain:** The default value is 2 and the value is adjustable among 0~9. It will influence the brightness of the image. The more the value is, the brighter the image is. However, the higher gain value might cause more noise.

### 7.2.7 Playback

Clicking the button of “Open Files” and select the video file recorded previous, you can look for the desired image. Then, you can have the live view in the screen. The function of each button is as below illustration:

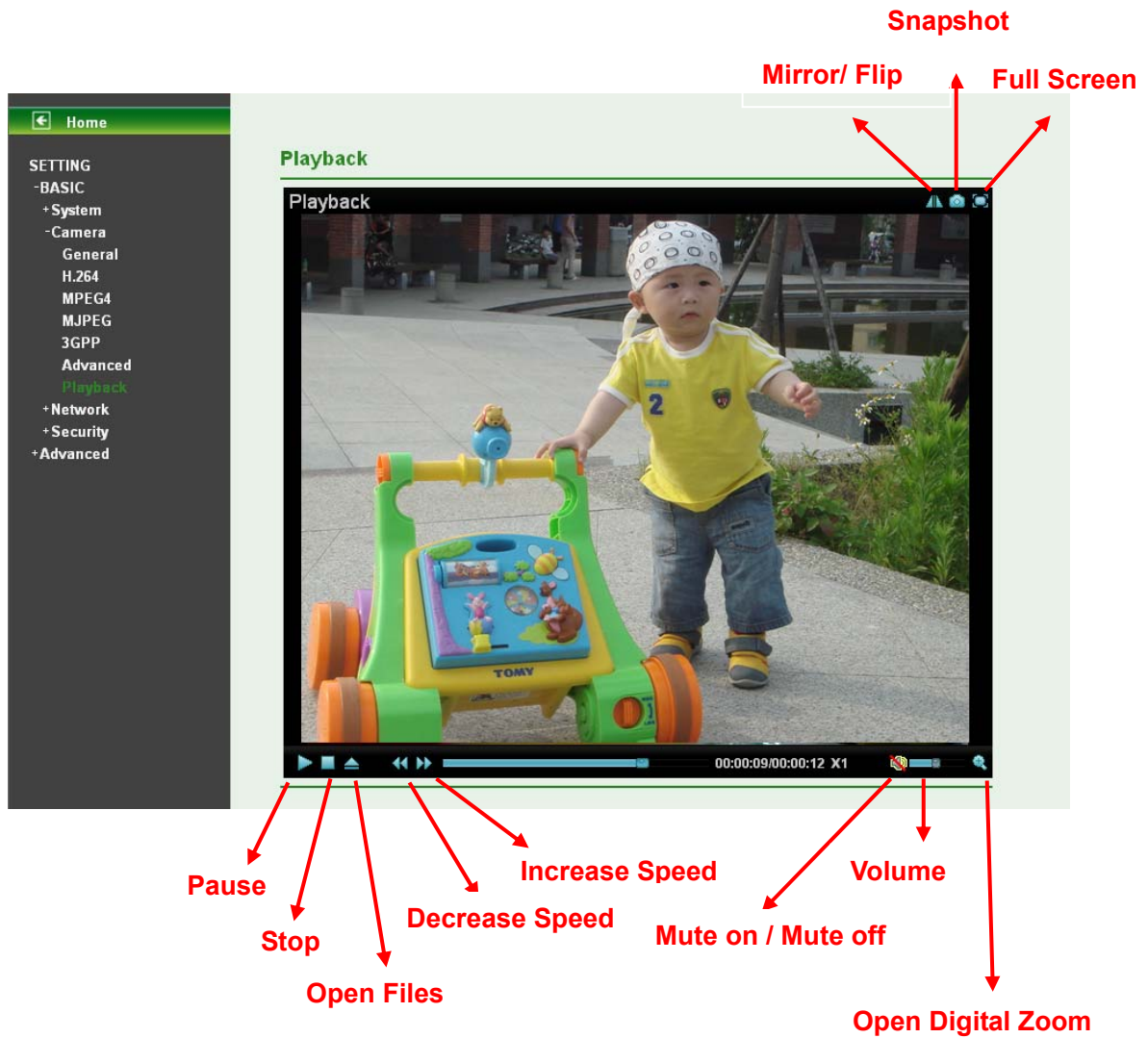

### 7.3 Network

Click the folder of Network to display the sub folders including Information, PPPoE, DDNS, UPnP, Bonjour, IP Notification and Messenger.

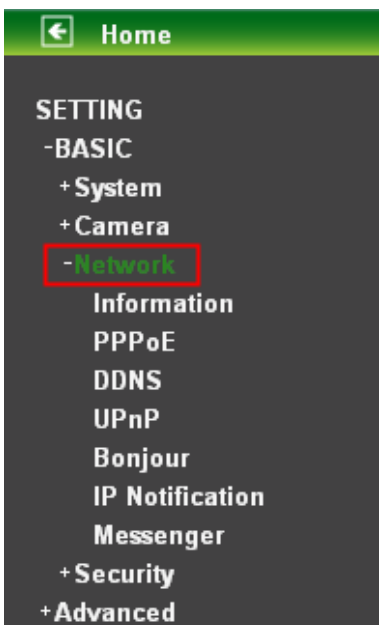



### 7.3.1 Information

Display the MAC address of the device.

Home

SETTING

- BASIC
  - + System
  - + Camera
  - Network
    - Information
    - PPPoE
    - DDNS
    - UPnP
    - Bonjour
    - IP Notification
    - Messenger
  - + Security
  - + Advanced

MAC address: 00:1B:FE:00:0B:A2

Obtain an IP address automatically (DHCP)

Use the following IP address

Obtain DNS server address automatically

Use the following DNS server address

HTTP port number:  80  1234 (1024 to 65535)

OK Cancel

- **Obtain an IP address automatically (DHCP):** If a DHCP server is installed on the network, to select this while the IP address is assigned by the DHCP server.
- **Obtain DNS server address automatically:** Select this to obtain the address of DNS server automatically.

Home

SETTING

- BASIC
  - + System
  - + Camera
  - Network
    - Information
    - PPPoE
    - DDNS
    - UPnP
    - Bonjour
    - IP Notification
    - Messenger
  - + Security
  - + Advanced

MAC address: 00:1B:FE:00:0B:A2

Obtain an IP address automatically (DHCP)

Use the following IP address

IP address: 192 . 168 . 1 . 100

Subnet mask: 255 . 255 . 255 . 0

Default gateway: 192 . 168 . 1 . 1

Use the following DNS server address

Primary DNS server: 192.168.1.1

Secondary DNS server: 0.0.0.0

HTTP port number:  80  1234 (1024 to 65535)

OK Cancel

- **Use the following IP address:** Select this option when the fixed IP address is set.
  - **IP address:** Enter the IP address of the device.
  - **Subnet mask:** Enter the subnet mask.
  - **Default gateway:** Enter the default gateway.
- **Use the following DNS server address:** Select this when you set the fixed address as the IP

address of DNS server.

- **Primary DNS server:** Enter the IP address of the primary DNS server.
  - **Secondary DNS server:** Enter the IP address of the secondary DNS server, if necessary.
- **HTTP Port Number:** Select **80** in general situations. If you want to use a port number other than **80**, select the text box and enter a port number between 1024 and 65535.
- When you have set the HTTP port number to a number other than 80 on the Network Setting screen in the Setup Program, access the device by typing the IP address of the device on the web browser as follows: Example: when HTTP port number is set to 2000 <http://192.168.1.100:2000/>

 **Note:**

- 1) The IP Camera needs to be rebooted after it finishes changing the network setting completely.
- 2) If you connect the IP Camera with your computer directly, the default network domain of camera is 192.168.1.xx

### 7.3.2 PPPoE

If your ISP provides Dynamic IP with authentication by username and password, type all PPPoE information in this part. When using the PPPoE function, you need to turn on the DDNS or IP Notification function at same time.



- **IP Address:** The IP address obtained at the PPPoE connecting with network.
- **User ID:** Enter the user ID for authentication necessary for PPPoE connections. Type it up to 64 characters.
- **Password:** Enter the password for authentication necessary for PPPoE connections. Type it up to 32 characters.
- **Re-type Password:** Re-type the password to confirm.
- **Obtain DNS server address automatically:** Select this to obtain the address of DNS server automatically.
- **Use the following DNS server address:** Select this when you set the fixed address as the IP address of DNS server.

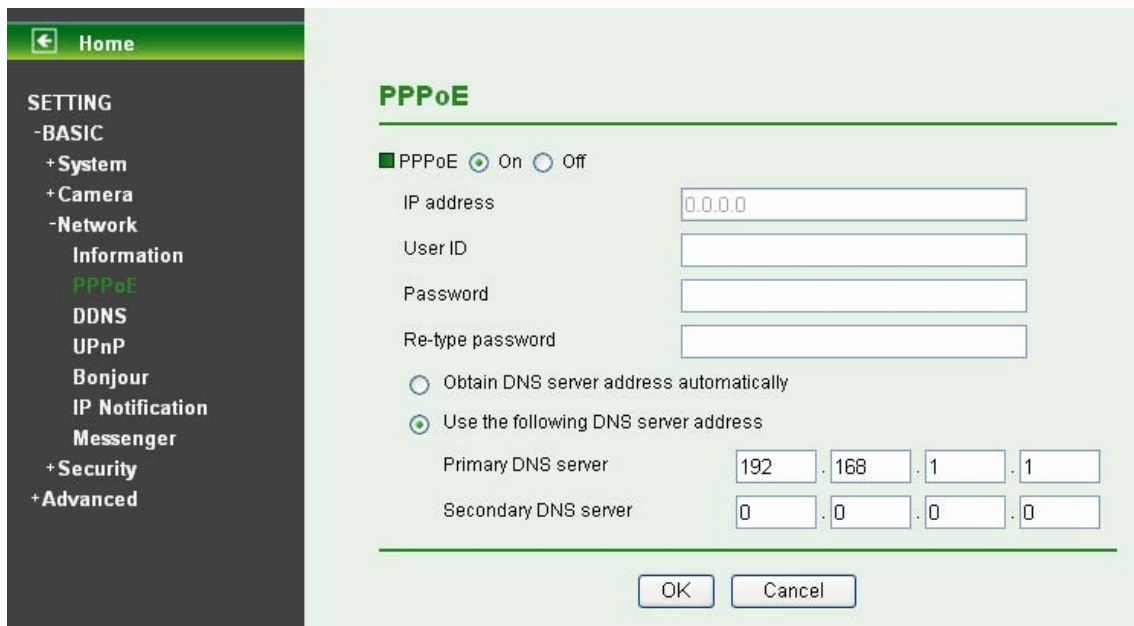

- **Primary DNS server:** Enter the IP address of the primary DNS server.
- **Secondary DNS server:** Enter the IP address of the secondary DNS server.

 **Note:**

- 1) PPPoE (Point-to-Point Protocol over Ethernet): PPPoE is a network protocol for encapsulating Point-to-Point Protocol frames inside Ethernet frames. PPPoE connection is used mainly with ADSL service where individual users connect to the ADSL transceiver (modem) over Ethernet work. It is also widely used in XDSL (digital affiliate line such as ADSL, VDSL or SDSL)
- 2) The IP Camera needs to be rebooted after it finishes changing the network completely. For more details, please refer to [Section 7.1.3 Initialize](#).
- 3) The IP Camera with Intelligent IP Installer can't be found after PPPoE is active, but you can get the IP address of the camera by IP Notification function. For the details, please refer to [Section 7.3.6 IP Notification](#).
- 4) If the IP Notification function is not configured to report the IP address of the camera, you can reset the camera to its factory default settings by pressing the Reset button. Then the camera can be found by Intelligent IP Installer.

### 7.3.3 DDNS (Dynamic DNS)

DDNS is a system which allows the domain name data held in a name server to be updated in real time. The most common use for DDNS is allowing an internet domain name to be assigned to a computer with a varying / dynamic IP Address. This makes it possible for other sites on the internet to establish connection to the machine without needing to track the IP Address themselves.



- **Server Name:** Choose the DDNS Server from the list.
- **User ID:** Enter the user ID for authentication necessary for DDNS connections. Type it up to 64 characters.
- **Password:** Enter the password for authentication necessary for DDNS connections. Type it up to 32 characters.
- **Re-type Password:** Re-type the password to confirm.
- **Host Name:** Enter the host name that is registered to the DDNS server.

**Note:**

**How to apply DDNS username and Host name?** You can apply DDNS username and Host name by the following steps:

1. Login <http://www.dyndns.org>, click the **Creat Account**.

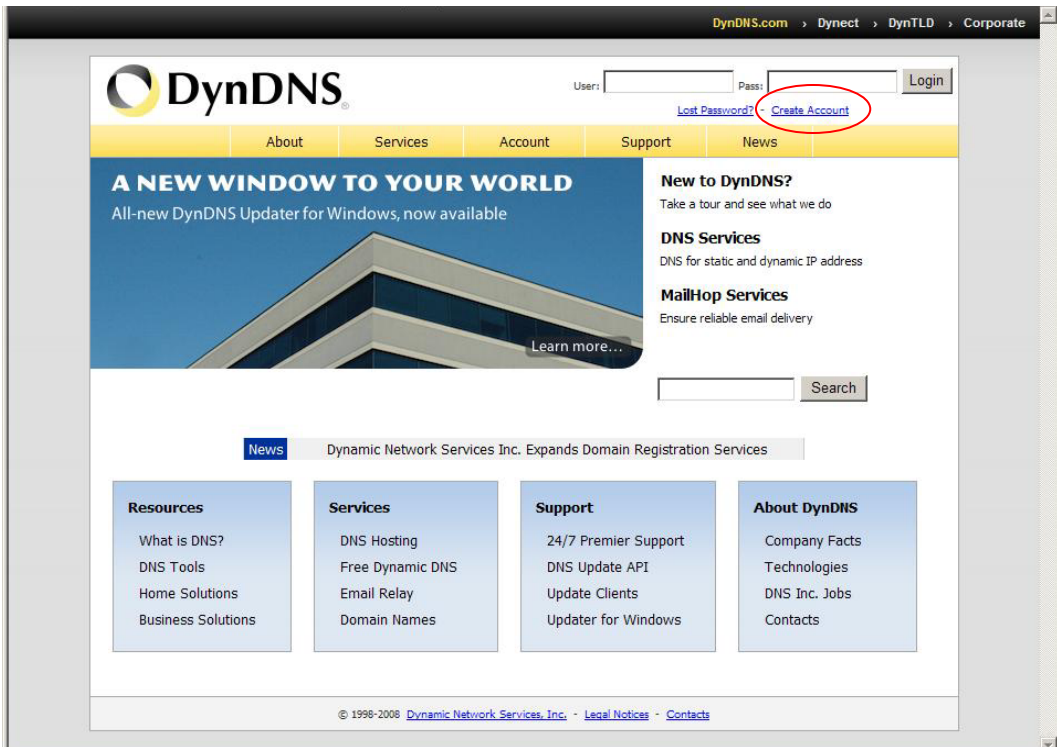

2. Input all information and follow step by step with DynDNS.

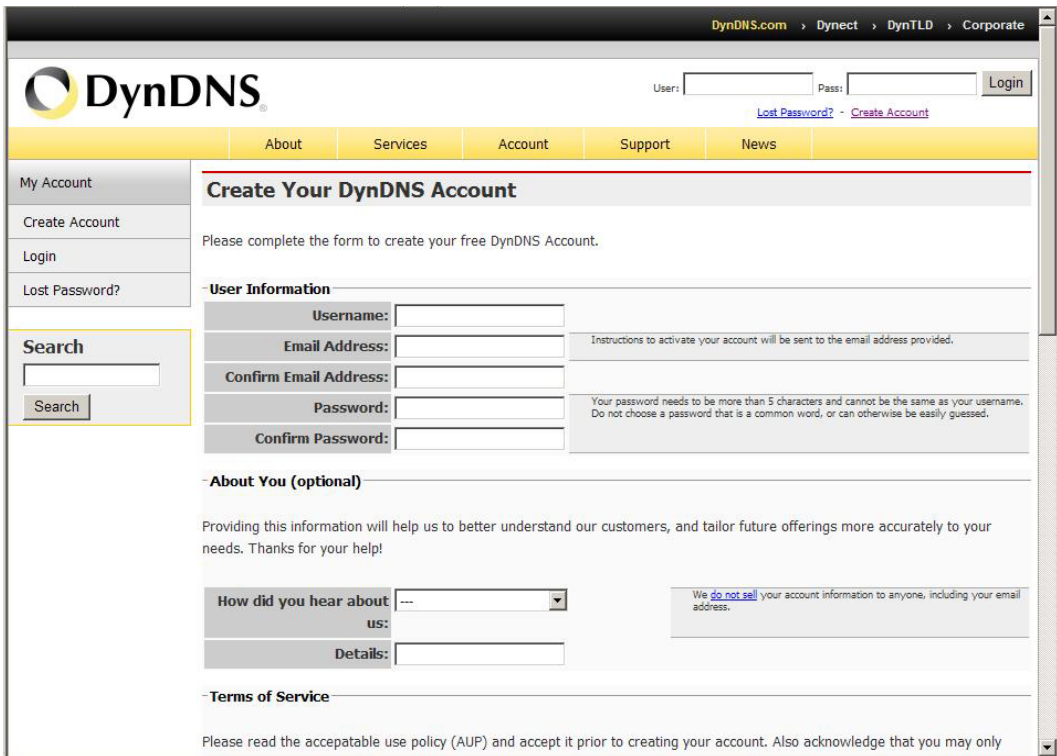

3. Login with new account and click **Account** → **My Hosts** → **Add Host Services**.

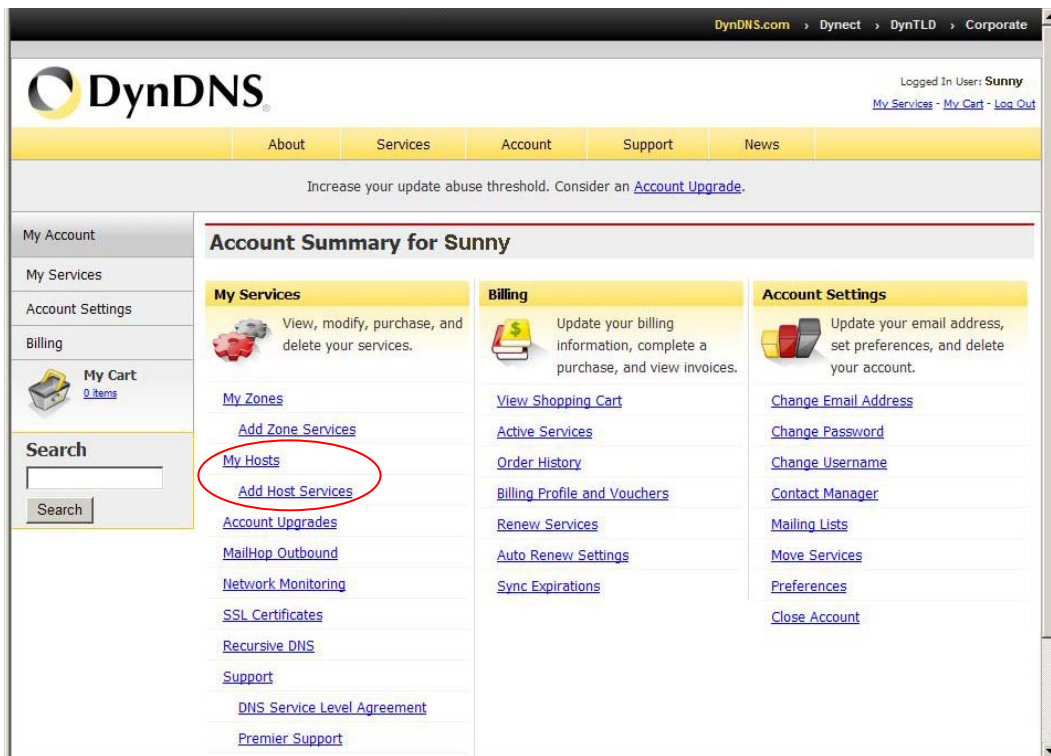

4. Type domain in the **Hostname** field and select **sub-domain**.

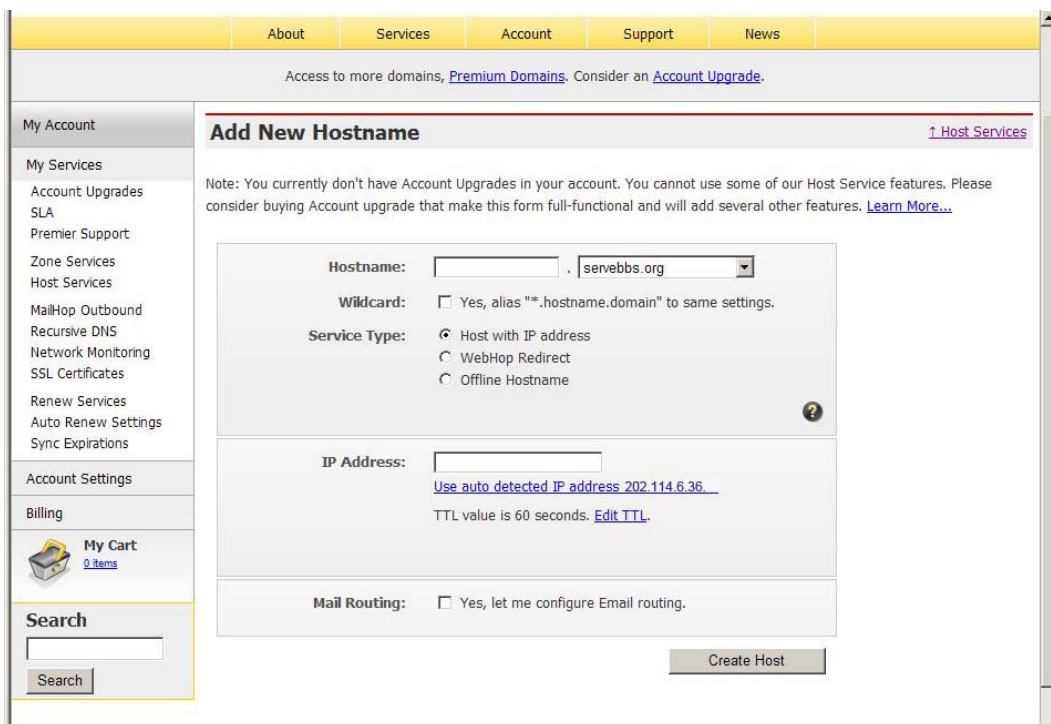

5. After typing information, check your DDNS service

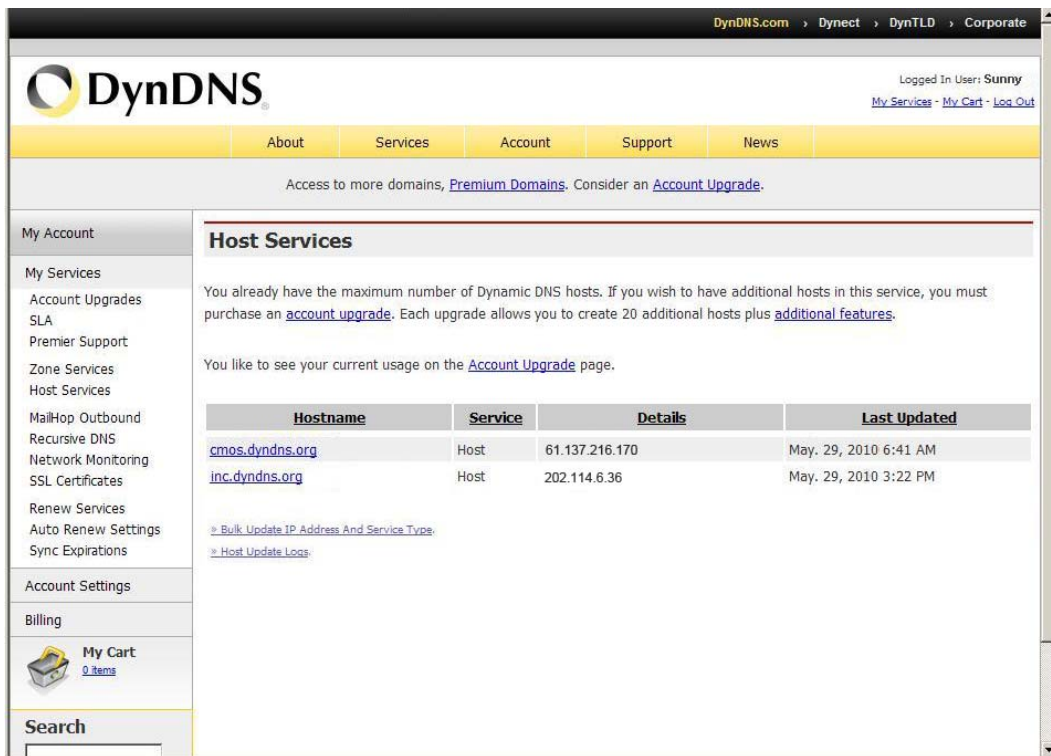

6. Type your DDNS User ID, Password and Host name in **Setting** → **Network** → **DDNS**. After completing setting, reboot IP Camera.

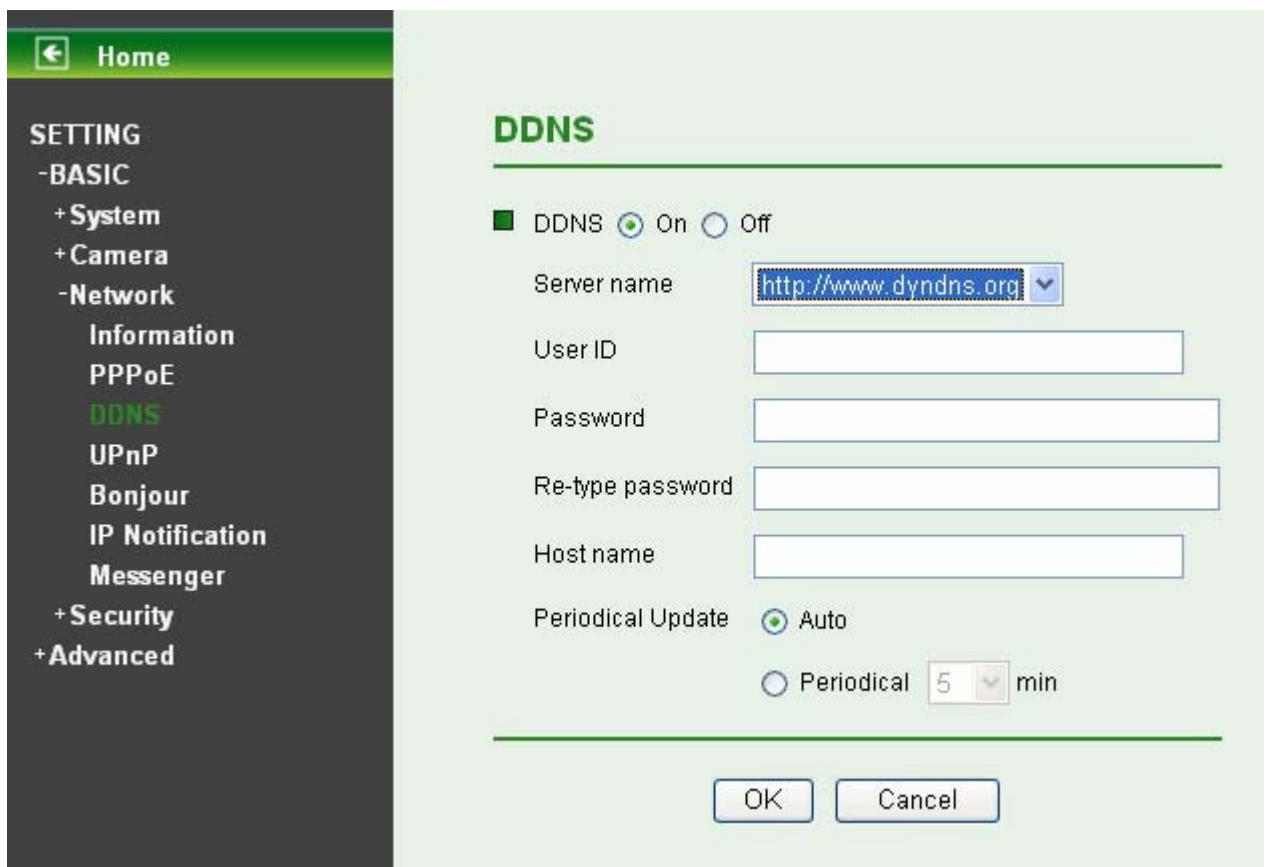

### 7.3.4 UPnP (Universal Plug and Play)

If you have a Router to access to internet and the Router supports UPnP IGD function, you need to turn on the UPnP Port Forwarding function.

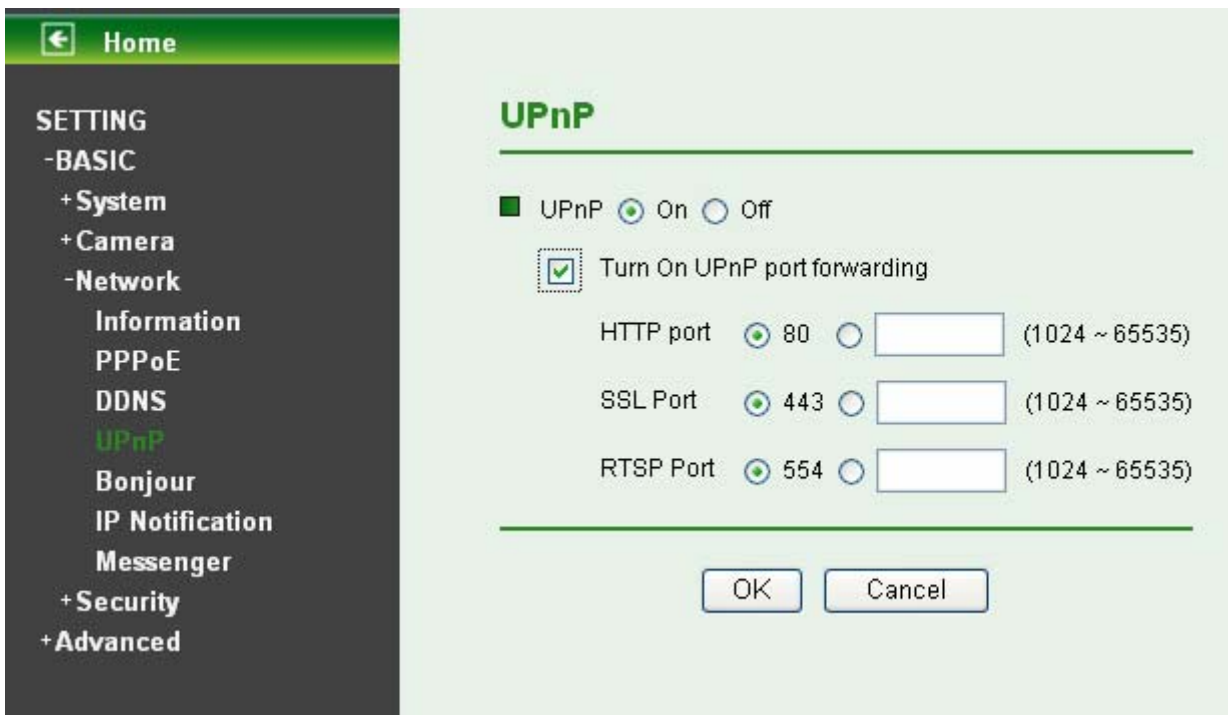

- **HTTP Port:** Enter the HTTP port number and default HTTP port is 80.
- **SSL Port:** Enter the SSL port number and default SSL port is 443.
- **RTSP Port:** Enter the RTSP port, default value is 554 for computer view.

 **Note:**

**UPnP (Universal Plug and Play):** UPnP is a set of computer network protocol. It allows devices to connect seamlessly and simplify the implementation of networks in the home and corporate environments.

### 7.3.5 Bonjour

Bonjour, also known as zero-configuration networking, enables automatic discovery of computers, devices, and services on IP networks. Bonjour uses industry standard IP protocols to allow devices to automatically discover each other without the need to enter IP addresses or configure DNS servers.

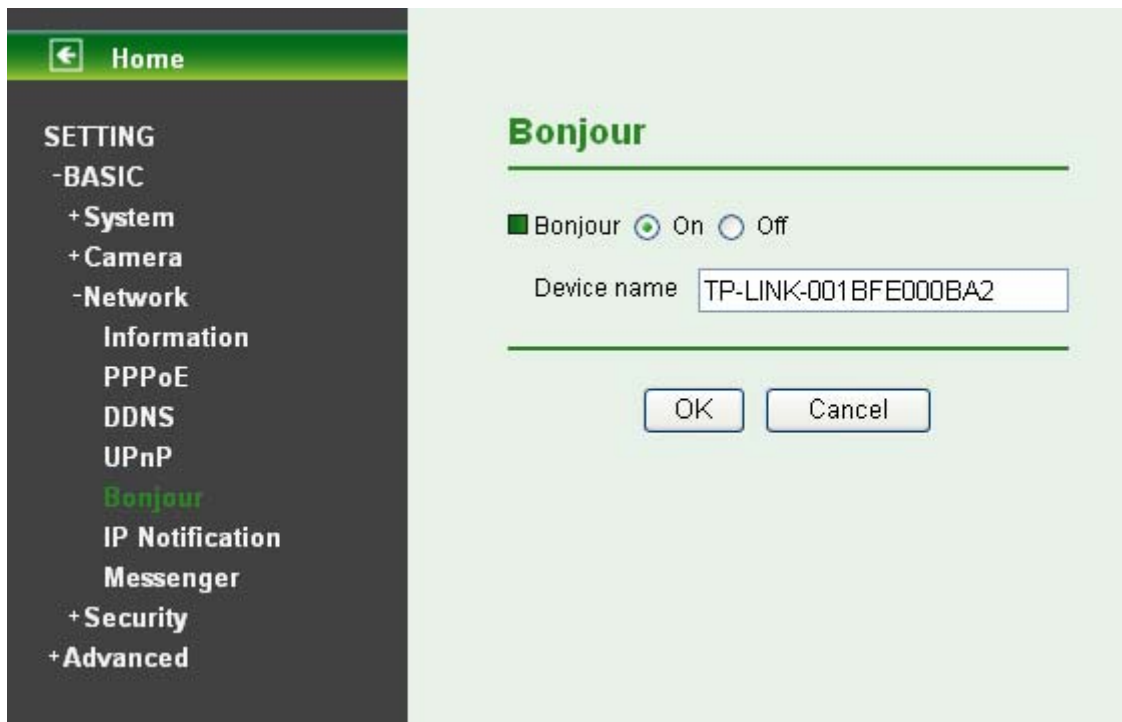

- **Device Name:** Enter Device Name you wish.

 **Note:**

How to use Bonjour in your Windows Browser UI? Please check the link below:

<http://www.apple.com/support/downloads/bonjourforwindows.html>

### 7.3.6 IP Notification

Once IP Notification is set to "On", the camera will automatically send an e-mail notification to tell users its updated network parameters if the network settings about IP address, network connection type, HTTP port or wireless connection is changed or completed. (Some settings will take effect after rebooting.)



- **Notify Type:** You can select the notify type among DHCP, Static IP, and PPPoE. When the network settings related to the chosen notify type are changed, an e-mail notification will be sent to inform you of the updated network information of the camera.
- **SMTP Server Name:** Type the SMTP server name up to 64 characters, or the IP address of the SMTP server.
- **SMTP Server Port:** You can set port number from 1~65535 according to your mail server. The default value is 25.
  - **Security setting:** Tick SSL box if the mail server you use has security restriction.

**Note:**

If you use g-mail as your mail server, you should set 25 as your port number and tick SSL box.

- **Authentication:** Select the authentication required when you send an email.
  - **Off:** Select if no authentication is necessary when an email is sent.
  - **On:** When authentication is necessary for sending an e-mail, there are three options: **SMTP**, **POP before SMTP** or **Both**.

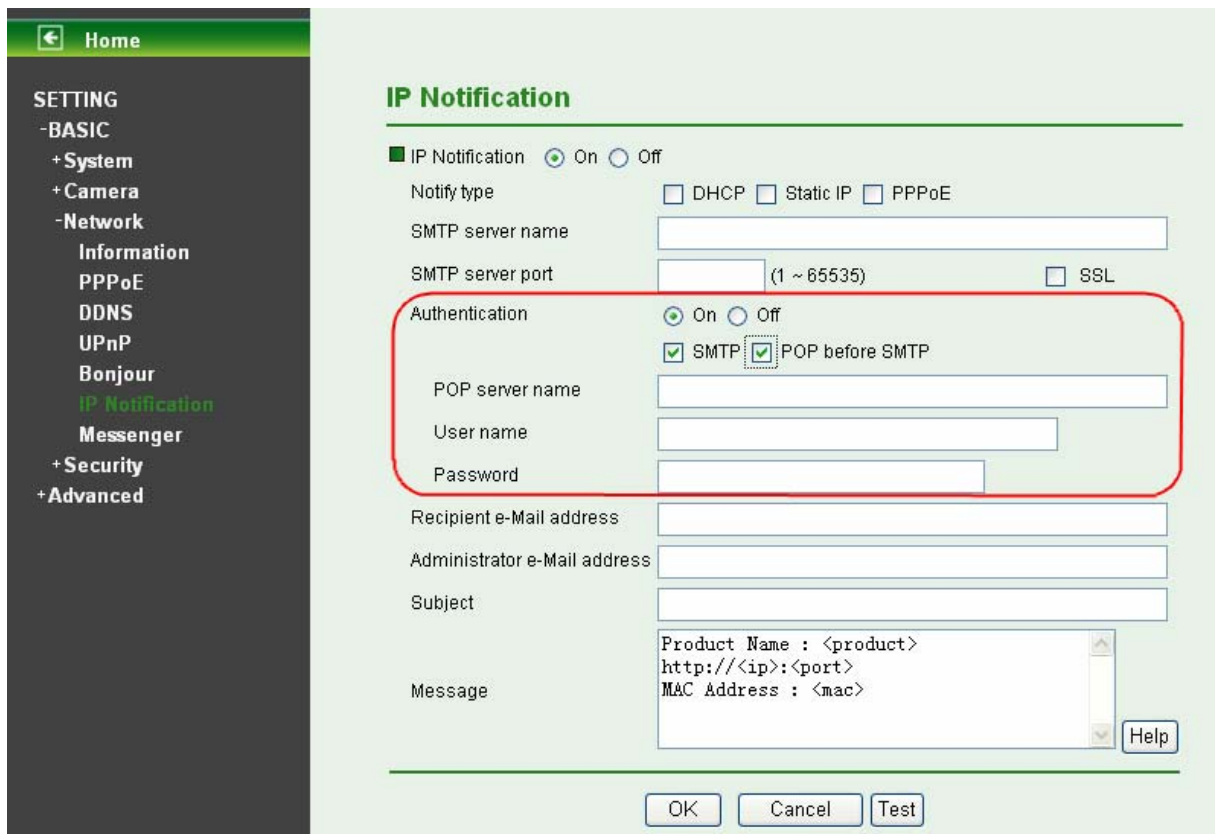

- **SMTP:** Select if SMTP authentication is necessary when an e-mail is sent.
- **POP before SMTP:** Select if POP before SMTP authentication is necessary when an e-mail is sent.
  - ✓ **POP server name:** It is necessary when the **POP before SMTP** is selected in **Authentication**. Type the POP (receiving mail) server name up to 64 characters, or type the IP address of the POP server. This setting is necessary when the SMTP server which sends e-mails performs authentication using the POP user account.
  - ✓ **User name, Password:** Type the user name and password of the user who has the mail account. This setting is necessary when the SMTP server which sends e-mails performs authentication.
- **Recipient E-mail Address:** Type the recipient e-Mail address up to 64 characters. You can specify up to three recipient E-mail addresses.
- **Administrator E-mail Address:** Type the Administrator e-Mail address up to 64 characters. This address is used for reply mail and sending system messages from the SMTP server.
- **Subject:** Type the subject/title of the e-Mail up to 64 characters. With respect to mail which is sent according to the IP notification.
- **Message:** Type the text of the E-mail up to 384 characters. Default value provides network information including IP, Port, MAC, Model, Firmware Version and Web Version.

### 7.3.7 Messenger

Messenger function provide an easy-connect feature. User can easy to know what camera's private and public IP address is.

 **Note:** For more details about MSN Messenger, please refer to [Chapter 5 MSN Menssenger](#).



- **Protocol:** support MSN only.
- **Login Account:** Camera will use this account to login MSN server. This MSN account should be applied form <http://www.msn.com>.
- **Password:** password for this msn account.
- **Re-type Password:** re-type password to double confirm.
- **Alias:** This alias will display on MSN like the following which display in red frame.
- **Port Range:** Camera will select one port from this port range for video transmission.
- **Video Mode:** You can choose to receive video streaming from Computer view(MPEG-4) or Mobile view (3GPP).
- **IP Notification:** Switch the IP notification On / Off. **If this feature switches On**, camera will send IP notification to the users who are allowed.
- **Privacy:** Switch privacy On / Off. **When privacy turns on**, only those users in allow list can access the camera
- **User:** Input to this blank to edit allow list.
- **Allow List:** When privacy turns on, only those users in allow list can access the camera.

## 7.4 Security

Click the folder of **Security** to display the sub folders including **Account** and **HTTPS**.

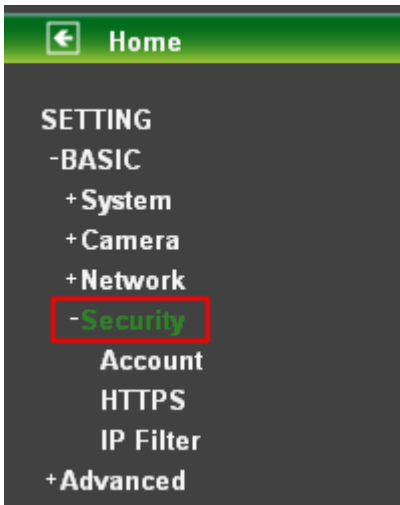

### 7.4.1 Account

The device fault account and password setting is “admin / admin”. That means everyone who knows IP address can access the device including all configuration. It is necessary to assign a password if the device is intended to be accessed by others.

User ID	User name	Password	Re-type Password	Viewer mode
Administrator	admin	*****	*****	Admin
User 1				Admin
User 2				Admin
User 3				Admin
User 4				Admin
User 5				Admin
User 6				Admin
User 7				Admin
User 8				Admin
User 9				Admin

Viewer authentication  On  Off

OK Cancel

- **User Name:** Set a user name between 4-16 characters.
- **Password:** Set a password between 4-16 characters.
- **Re-type Password:** Re-type the password to confirm.
- **Viewer Mode:** Set the user mode among Admin, Operator, and Viewer. Different viewer mode has different limits of authority.
  - The Admin mode has all authority of configuration.

- The Operator mode can not only view the Live View but also control the PTZ (only for PTZ models).
  - The Viewer mode only can view the Live View.
- **Viewer Authentication:** Select whether the authentication is needed when users access to live view.
- **On:** Authentication is required to let different users have different levels of permission to access the camera view.
  - **Off:** Authentication is not required to access the camera. Check **Off** and select one (among **Admin**, **Operator** and **Viewer**) from the pull-down list as the permission, then all users can view directly the video with the default permission without entering username and password.
- \* If you want to have a higher authority than the default, you can key in appropriate username and password in the diag box that pops up when performing advanced operations that are only allowed by the higher authority.

## 7.4.2 HTTPS

**HTTPS** is a URL scheme used to indicate a secure HTTP connection. It is syntactically identical to the `http://` scheme normally used for accessing resources using HTTP. Using an `https://URL/` with a different default TCP port (443) and an additional encryption/authentication layer between the HTTP and TCP. You can use the IP camera through HTTPS easily by using `https://` instead of `http://`.

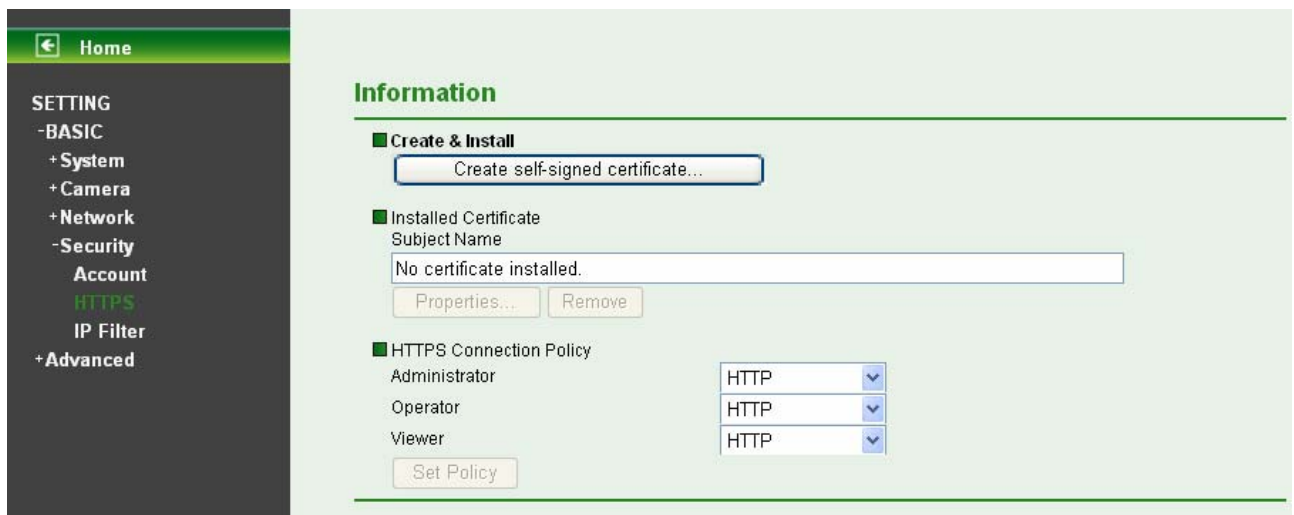

- **Create & Install:** Create a self-signed certificate for HTTPS to recognize.
- **Installed Certificate:** Display or remove the properties of the installed certificate.
- **HTTPS Connection Policy:** Set HTTPS connection policy for different level of users.
- To use the HTTPS encryption, please set up “**Create self-signed certificate**” for the first time you use the HTTPS function, and then set up the connection policy for different users.

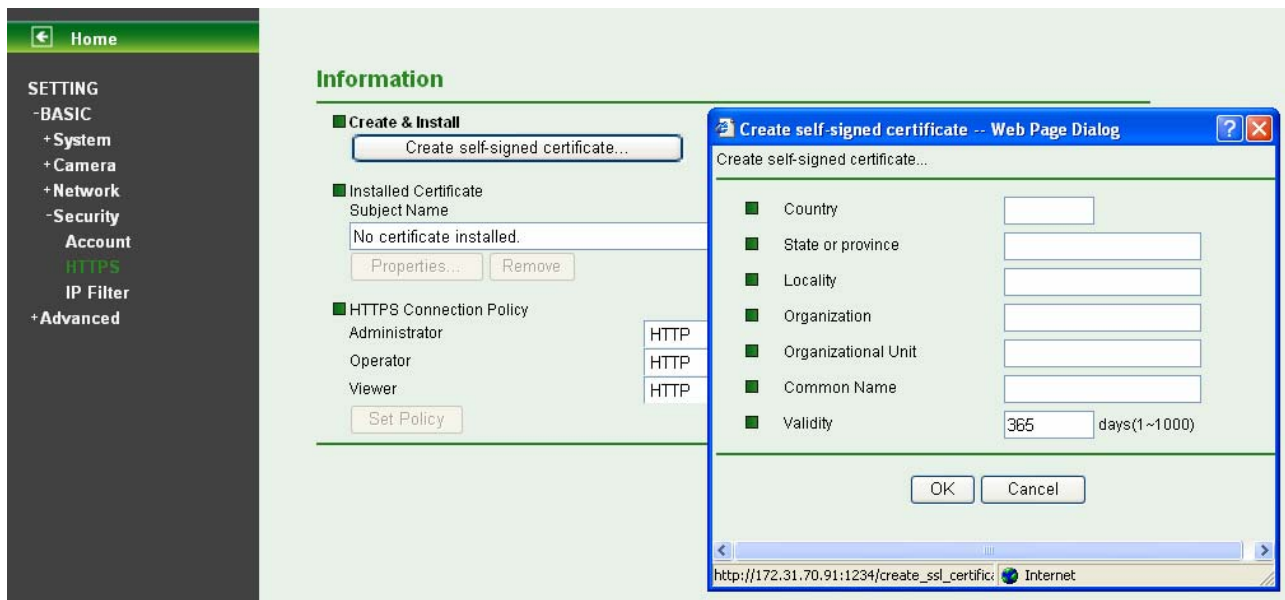

**Note:**

When enable HTTPS with RTSP on mode, the IP Camera only protect the setting such as username and password and do not protect video and audio. When enable HTTPS with RTSP off mode, the IP Camera will protect all setting including video and audio.

### 7.4.3 IP Filter

IP Filter provides the function of controlling the range of IP address, similar with firewall service. This feature can only be applied to the users with the right of Operator or Viewer except the Admin users.

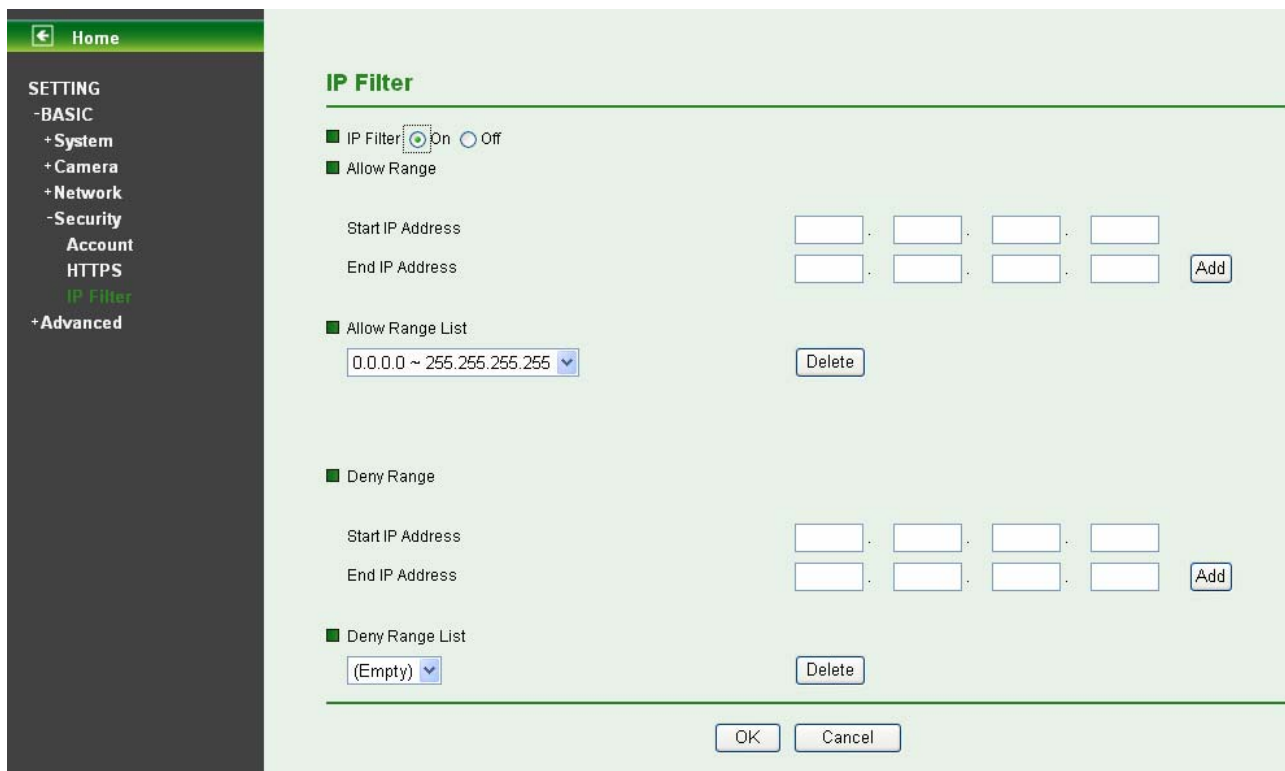

- **IP Filter:** Select if you would like to have IP filter function.
- **Allow Range:** The default range is from 0.0.0.0 to 255.255.255.255. Enter the “Start IP address” and “End IP address” in the range, then you can add a new allow range in allow range

list.

- **Allow Range List:** Except the default range 0.0.0.0~255.255.255.255, the list allows to add four more sets of allow range at most.
- **Deny Range:** You can define the deny range by entering “Start IP address” and “End IP address”
- **Deny Range List:** You can define not more than five sets of deny range in the list.

## Chapter 8 Setting-Advanced

Click the folder of Advanced to display the sub folders including **FTP client**, **SMTP**, **Network storage**, **Schedule**, **Alarm buffer**, **Motion detection**, **Audio detection**, and **System Log**.

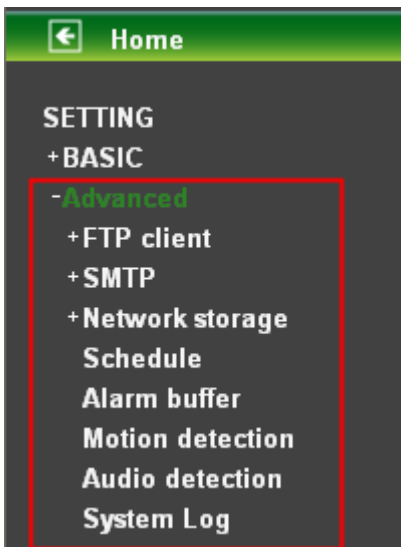

### 8.1 FTP Client

Use this menu to set up for capturing and sending a image or video clip to an FTP server. By using FTP client function, you can send files which has been shot and recorded linked with the external sensor input or with the built-in motion detection function to FTP server. FTP client setting menu is composed of three tabs, **General**, **Alarm Sending** and **Periodical Sending**.

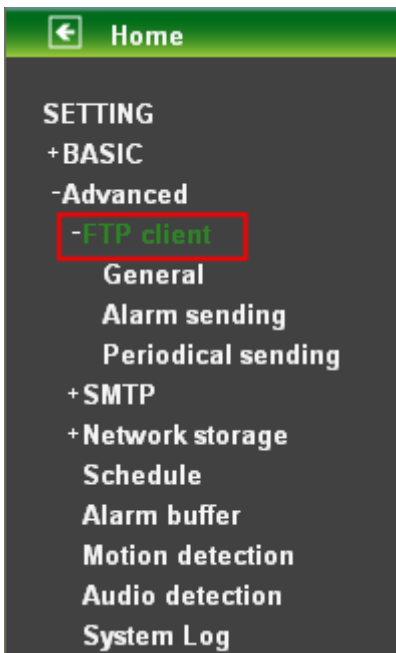

#### 8.1.1 General

Select **On** when you use FTP function. The FTP client Setting screen appears.

Select **Off**, when you do not wish to use the FTP client function.

 **Note:**

The frame rate and operability on the main viewer may decrease while a file is being transmitted by the FTP client function.

- **FTP Server Name:** Type the FTP server name to upload still images up to 64 characters, or the IP address of the FTP server.
- **User Name:** Type the user name for the FTP server.
- **Password:** Type the password for the FTP server.
- **Retype Password:** To confirm the password, type the same characters as you typed in the Password box.
- **Passive Mmode:** Set whether you use the passive mode of FTP server or not when connecting to FTP server. Select **On** to connect to FTP server using the passive mode.
- **Attached File Type:** You can choose snapshot or video clip for alarm sending. Select “Snapshot,” one snapshot will be transmitted to the specified FTP server while motion detection / audio detection triggered. Select “Video clip,” one 5-seconds video clip will be transmitted.
- **Test:** After setting the FTP server information, you can tick the test key to test if the connection between IP CAM and FTP server works.

### 8.1.2 Alarm Sending

Set to forward a snapshot or video clip file to the specified FTP server linked with the alarm detection by the external sensor input or by the built-in motion detection function. Select **On** to send the file to FTP server linked with the alarm detection.

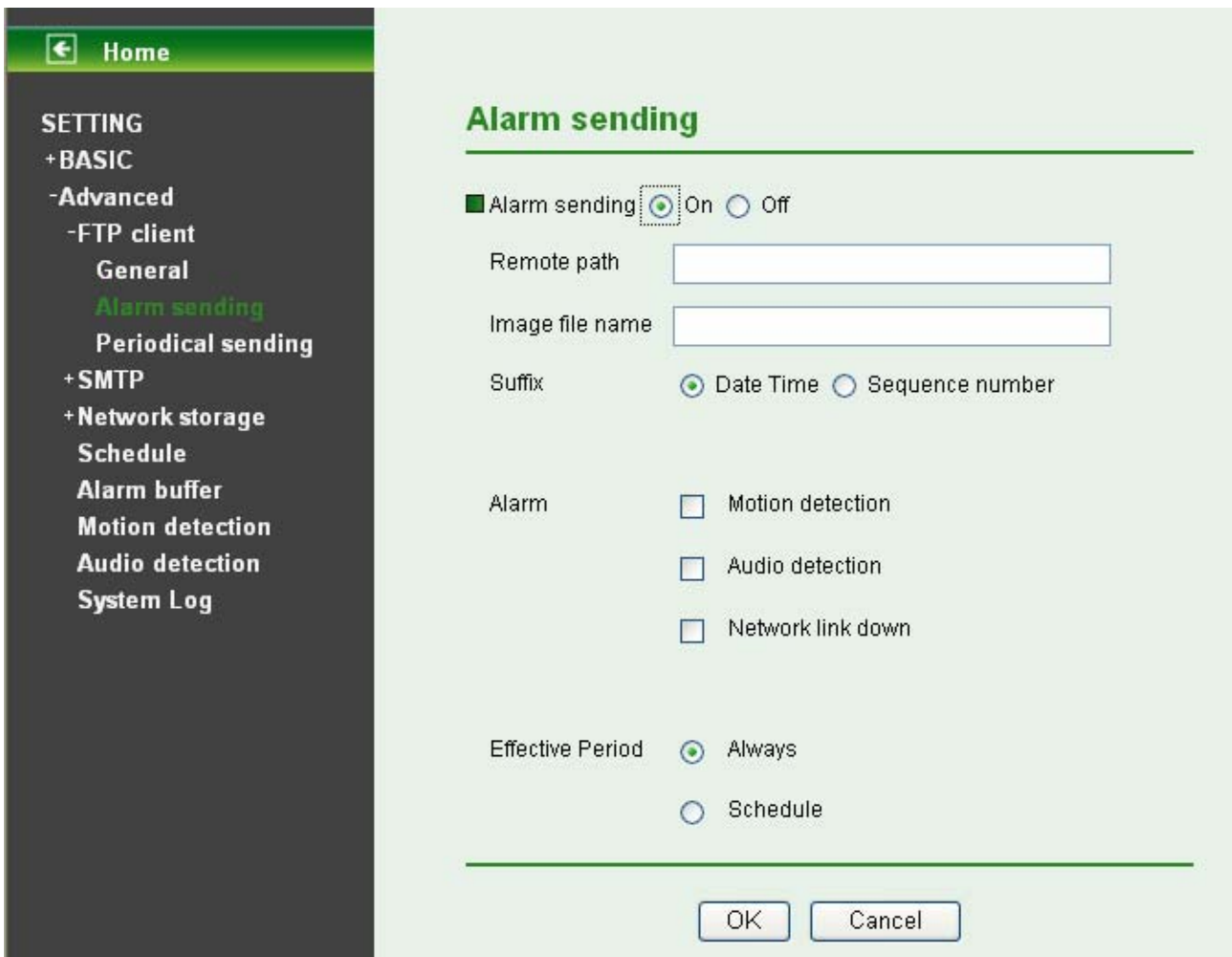

- **Remote Path:** Type the path to the destination in FTP server up to 64 characters.
- **Image File Name:** Type the file name you want to assign to the files when sending to the FTP server. You can use up to 10 alphanumeric characters, - (hyphen) and \_ (underline) for naming.
- **Suffix:** Select a suffix to add to the file name
  - **Date & time:** The date & time suffix is added to the Image file name. The date/time suffix consists of lower two-digits of year (2 digits), month (2 digits), date (2 digits), hour (2 digits), minute (2 digits), second (2 digits), and consecutive number (2 digits), thus 14-digit number is added to the file name.
  - **Sequence number:** A consecutive number of 10 digits between 1 and 4294967295 and two fixed digits 00 is added to the Image file name.
  - **Sequence number clear:** Click **Clear** and the suffix of the sequence number returns to 1.
- **Alarm**
  - **Motion Detection:** Click it on for using **Motion Detection** function as a sensor. You can set motion detection function at the motion detection function screen.

**Note:**

You can set motion detection at motion detection screen. (Please go “**Setting** → **Advanced** → **Motion Detection** → **Setting**”) For more details, you can check **Chapter 9.6**.

- **Audio Detection:** Click it on for using **Audio Detection** function as a sensor. You can set audio detection function at the audio detection function screen.

**Note:**

You can set audio detection at audio detection screen. (Please go “**Setting** → **Advanced** → **Audio**”)



**Detection** → **Setting**") For more details, you can check **Chapter 9.7**.

- **Network Link Down:** Click it on to receive a snapshot or a video clip while network link down. If **Attached File Type** (go "**Setting** → **Advanced** → **FTP Client** → **General**") was clicked as **video clip**, you can use **Alarm Buffer** function as a sensor. It's for recording audio file in the IP CAM before and after disconnected network.

 **Note:**

You can set alarm buffer at alarm buffer screen. (Please go "**Setting** → **Advanced** → **Alarm Buffer** → **Setting**") For more details, you can check **Chapter 9.5**.

- **Effective Period:** Set the period when the periodical sending is effective.
  - **Always:** The periodical sending is always effective.
  - **Schedule:** You can specify the period when the periodical sending is effective in the Schedule setting in the other section.

 **Note:**

You can set schedule function at schedule screen. (Please go "**Setting** → **Advanced** → **Schedule** → **Setting**") For more details, you can check **Chapter 9.4**.

### 8.1.3 Periodical Sending

Select **On**, you can set to send an image file to FTP server periodically.

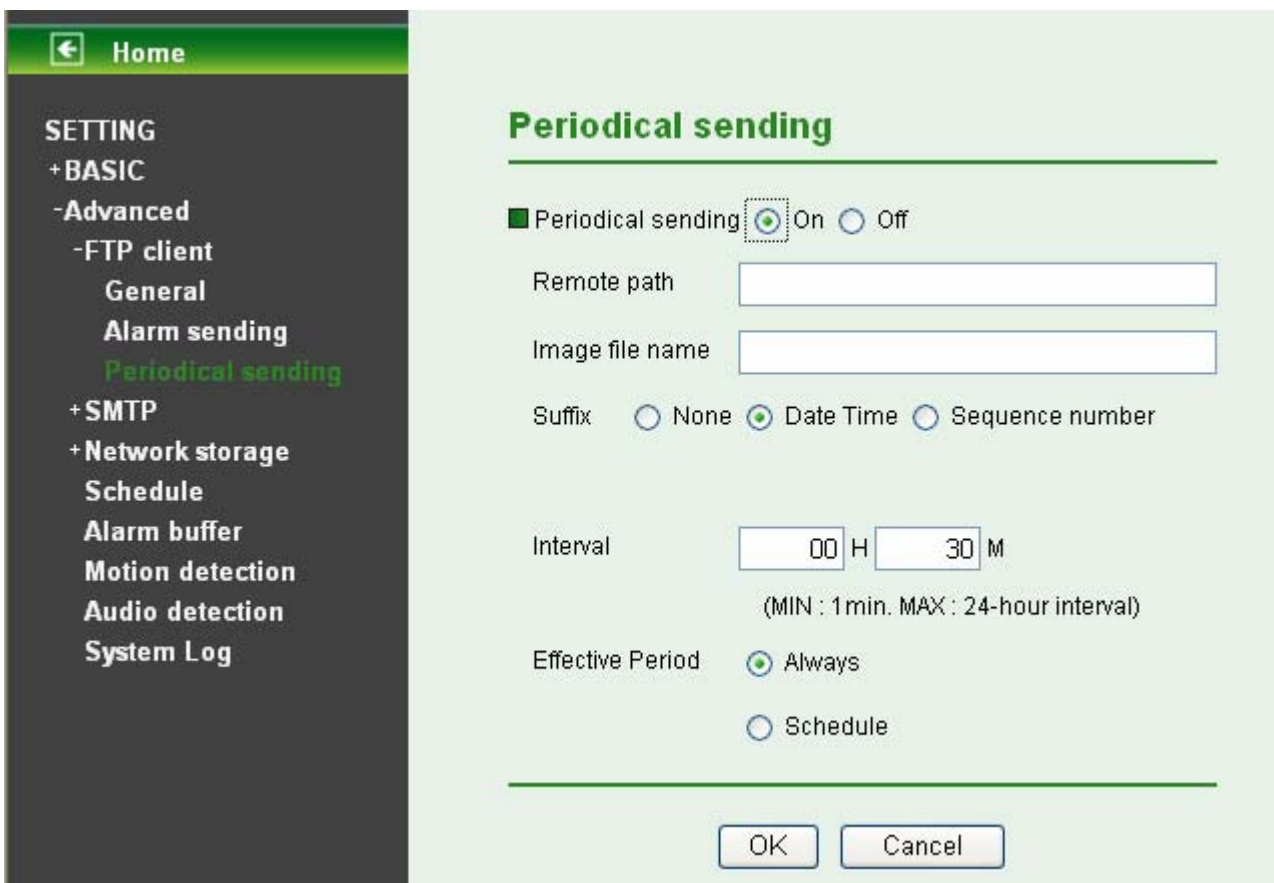

- **Remote Path:** Type the path to storage location of FTP server which you have authorized.
- **Image File Name:** Type the file name of snapshot or video clip sent by SMTP up to 10 alphanumeric characters, - (hyphen) and \_ (under score).
- **Suffix:** Select a suffix to be added to the file name sent by SMTP.
  - **None:** The name of the sent file will be the Image file name.
  - **Date & time:** The date & time suffix is added to the Image file name. The date & time suffix

consists of lower two-digits of year (2 digits), month (2 digits), date (2 digits), hour (2 digits), minute (2 digits) and second (2 digits), and consecutive number (2 digits), thus 14-digit number is added to the file name.

- **Sequence number:** A **consecutive** number is added to the Image file name.
- **Sequence number clear:** Click **Clear** and the suffix of the sequence number returns to 1.
- **Interval:** Set the periodical sending is effective interval. Min value is 1 min and Max value is 24 hour.
- **Effective Period:** Set the period when the periodical sending is effective.
  - **Always:** The periodical sending is always effective.
  - **Schedule:** You can specify the period when the periodical sending is effective in the schedule setting in the other section. **Please check “Setting → Advanced → Schedule → Setting”.**

 **Note:**

You can set schedule function at schedule screen. (Please go “Setting → Advanced → Schedule → Setting”) For more details, you can check Chapter 9.4.

## 8.2 SMTP

Set the SMTP menu when you want to send an image or video clip via e-mail. By using Mail (SMTP) function, you can send a mail with attached file which has been shot linked with the external sensor input or with the built-in motion detection function. The file can also be sent periodically. E-Mail (SMTP) setting menu is composed of three tabs, **General**, **Alarm Sending** and **Periodical Sending**.

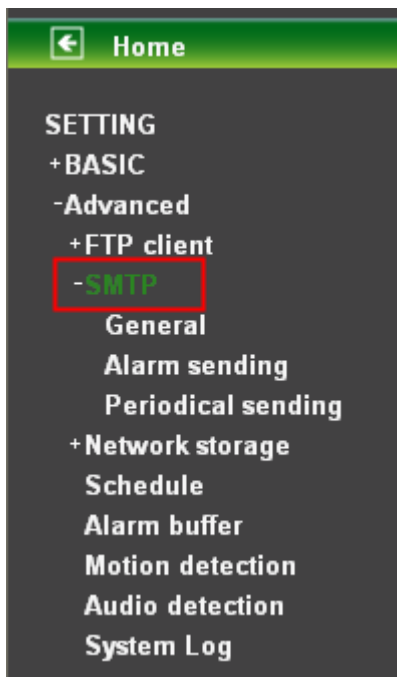

### 8.2.1 General

Select **On** when you use the SMTP function. The common setting options are displayed below. Select **Off**, if you do not wish to use the E-mail (SMTP) function.

 **Note:**

The Setting of general part will be the same as IP Notification. (Please check “Setting → Basic → Network → IP Notification”)

The screenshot shows the 'General' settings for e-Mail (SMTP). The 'e-Mail (SMTP)' option is turned 'On'. The 'SMTP server name' is set to 'smtp.abchk.com'. The 'SMTP server port' is set to '25' (range 1~65535). The 'Authentication' is set to 'On', with 'SMTP' and 'POP before SMTP' both checked. The 'POP server name', 'User name', and 'Password' fields are empty. The 'Recipient e-Mail address' and 'Administrator e-Mail address' fields are also empty. The 'Attached file type' is set to 'Snapshot'. The 'Subject' is set to 'test'. The 'Message' field is a large black box. At the bottom, there are 'OK', 'Cancel', and 'Test' buttons.

- **SMTP Server Name:** Type the SMTP server name up to 64 characters, or the IP address of the SMTP server.
- **SMTP Server Port:** You can set port number from 1~65535 according to your mail server. The default value is 25.
  - **Security setting:** Tick SSL box if the mail server you use has security restriction.

**Note:**

If you use g-mail as your mail server, you should set 25 as your port number and tick SSL box.

- **Authentication:** Select the authentication required when you send an email.
  - Off: Select if no authentication is necessary when an email is sent.
  - On: When authentication is necessary an e-mail is sent, select one of the authentication methods from the followings.
- **SMTP:** Select if SMTP authentication is necessary when an e-mail is sent.
- **POP Before SMTP:** Select when POP before SMTP authentication is necessary when an e-mail is sent.

**Note:**

When you set to On, be sure to select either or both SMTP or / and POP before SMTP.

- **POP server name:** It is necessary when the **POP before SMTP** is selected in **Authentication**. Type the POP (receiving mail) server name up to 64 characters, or type the IP address of the POP server. This setting is necessary when the SMTP server which sends e-mails performs authentication using the POP user account.
- **User name, Password:** Type the user name and Password of the user who has the mail account. This setting is necessary when the SMTP server which sends e-mails performs authentication.

- **Recipient E-mail Address:** Type the recipient e-Mail address up to 64 characters. You can specify up to three recipient E-mail addresses.
- **Administrator E-mail Address:** Type the Administrator e-Mail address up to 64 characters. This address is used for reply mail and sending system messages from the SMTP server.
- **Attached File Type:** You can choose snapshot or video clip for alarm sending. Select “Snapshot,” one snapshot will be transmitted to the administrator’s e-mail address while motion detection / audio detection triggered. Select “Video Clip,” one 5-seconds video clip will be transmitted.
- **Subject:** Type the subject/title of the e-Mail up to 64 characters. With respect to mail which is sent according to the alarm detection when **Alarm sending** of the alarm tab is set to **On**, the characters standing for the sensor type added to the subject.
- **Message:** Type the text of the E-mail up to 384 characters. (A line break is equivalent to 2 characters.)
- **Test:** After setting the SMPT server information, you can tick the test key to test if the connection between IP CAM and the SMPT server works.

## 8.2.2 Alarm Sending

Set to send the mail with connection to the alarm detection by the external sensor input or by the built-in motion detection function. Select On to send the image file to SMTP server linked with the alarm detection.

The screenshot shows the 'Alarm sending' configuration page. The sidebar on the left contains a 'Home' button and a menu with the following items: SETTING, +BASIC, -Advanced, +FTP client, -SMTP, General, Alarm sending (highlighted in green), Periodical sending, + Network storage, Schedule, Alarm buffer, Motion detection, Audio detection, and System Log. The main content area is titled 'Alarm sending' and contains the following configuration options:

- Alarm sending  On  Off
- File attachment  On  Off
- Image file name
- Suffix  None  Date Time  Sequence number
- Sequence number clear
- Alarm
  - Motion detection
  - Audio detection
  - Network link down
- Effective Period  Always  Schedule

At the bottom of the page are  and .

- **Alarm Sending:** Select **On** to set to send mail with connection to the alarm detection.

- **File Attachment:** Set whether an image file is attached to the mail sent or not. When **On** is selected, the image file made by the settings below is attached. When **Off** is selected, only the message is sent.
- **Image File Name:** Type the file name you want to assign to the file attached to a mail. You can use up to 10 alphanumeric, - (hyphen) and \_ (underscore) for naming.
- **Suffix:** Select a suffix to add to the file name
  - **None:** The name of the sent file will be the Image file name.
  - **Date & time:** The date & time suffix is added to the Image file name. The date & time suffix consists of lower two-digits of year (2 digits), month (2 digits), date (2 digits), hour (2 digits), minute (2 digits) and second (2 digits), and consecutive number (2 digits), thus 14-digit number is added to the file name.
  - **Sequence number:** A **consecutive** number is added to the Image file name.
  - **Sequence number clear:** Click **Clear** and the suffix of the sequence number returns to 1.
- **Alarm**
  - **Motion Detection:** Click it on for using **Motion Detection** function as a sensor. You can set motion detection function at the motion detection function screen.

 **Note:**

You can set motion detection at motion detection screen. (Please go “**Setting** → **Advanced** → **Motion Detection** → **Setting**”) For more details, you can check **Chapter 9.6**.

- **Audio Detection:** Click it on for using **Audio Detection** function as a sensor. You can set audio detection function at the audio detection function screen.

 **Note:**

You can set audio detection at audio detection screen. (Please go “**Setting** → **Advanced** → **Audio Detection** → **Setting**”) For more details, you can check **Chapter 9.7**.

- **Network Link Down:** Click it on to receive a snapshot or a video clip while network link down. If **Attached File Type** was clicked as **video clip** (go “**Setting** → **Advanced** → **FTP Client** → **General**”) , you can using **Alarm buffer** function as a sensor. It's for recording audio file in the IP CAM before and after disconnected network.

 **Note:**

You can set alarm buffer at alarm buffer screen. (Please go “**Setting** → **Advanced** → **Alarm Buffer** → **Setting**”) For more details, you can check **Chapter 9.5**.

- **Effective Period:** Set the period when the periodical sending is effective.
  - **Always:** The periodical sending is always effective.
  - **Schedule:** You can specify the period when the periodical sending is effective in the Schedule setting in the other section.

 **Note:**

You can set schedule function at schedule screen. (Please go “**Setting** → **Advanced** → **Schedule** → **Setting**”) For more details, you can check **Chapter 9.4**.

### 8.2.3 Periodical Sending

You can set to send an image file by SMTP server periodically by selecting **On** to send the image file by SMTP server linked with setting period.

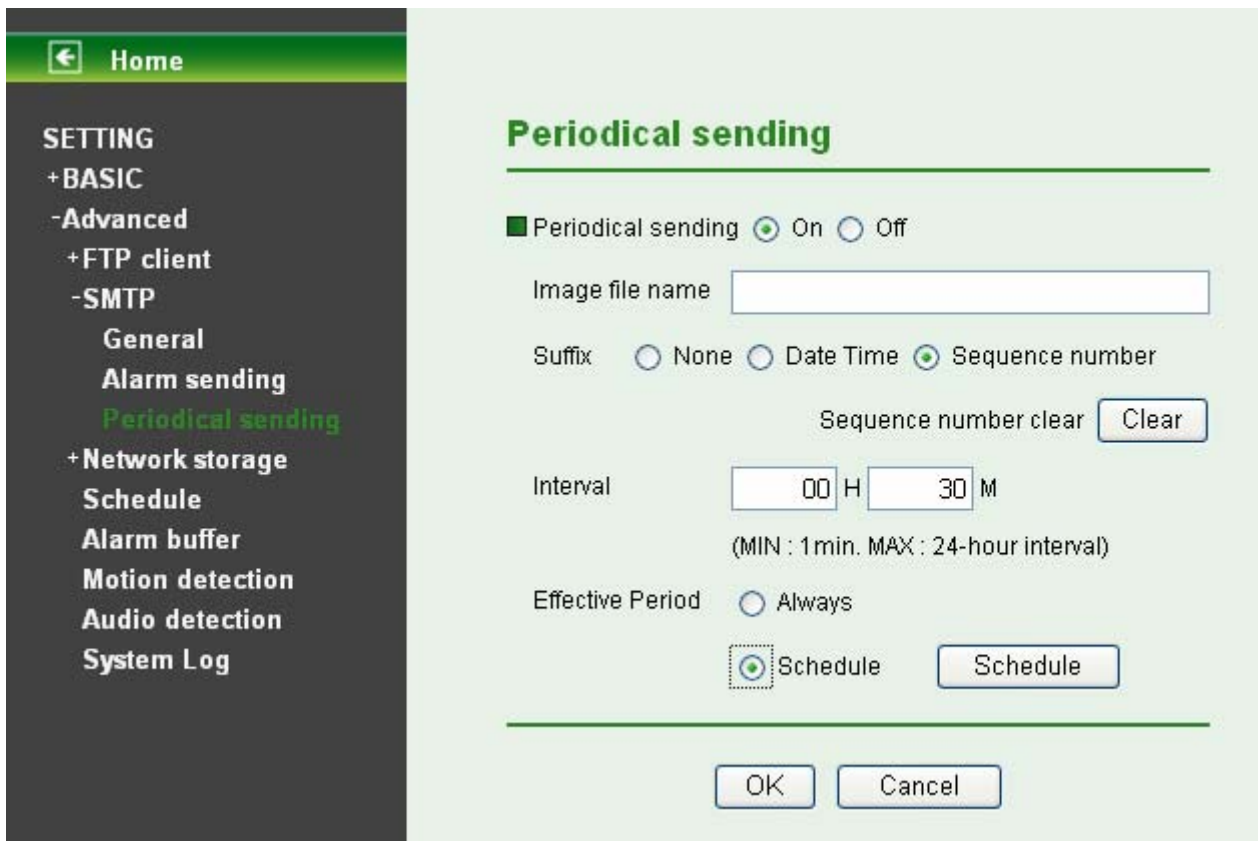

- **Image File Name:** Type the file name of the image sent by SMTP up to 10 alphanumeric characters, - (hyphen) and \_ (under score).
- **Suffix:** Select a suffix to be added to the file name sent by SMTP.
  - **Date & time:** The date & time suffix is added to the Image file name. The date & time suffix consists of lower two-digits of year (2 digits), month (2 digits), date (2 digits), hour (2 digits), minute (2 digits) and second (2 digits), and consecutive number (2 digits), thus 14-digit number is added to the file name.
  - **Sequence number:** A consecutive number is added to the Image file name.
  - **Sequence number clear:** Click **Clear** and the suffix of the sequence number returns to 1.
- **Interval:** Set the effective interval of periodical sending. Min value is 1 min and Max value is 24 hour.
- **Effective Period:** Set the period when the periodical sending is effective.
  - **Always:** The periodical sending is always effective.
  - **Schedule:** You can specify the period when the periodical sending is effective in the schedule setting in the other section. **Please check “Setting → Basic → Advanced → Schedule → Setting.”**

**Note:**

You can set schedule function at schedule screen. (Please go **“Setting → Advanced → Schedule → Setting”**) For more details, you can check **Chapter 8.4**.

### 8.3 Network Storage

Network storage provides the storage function for saving image files to the specified computer and folder connected with the operating computer.

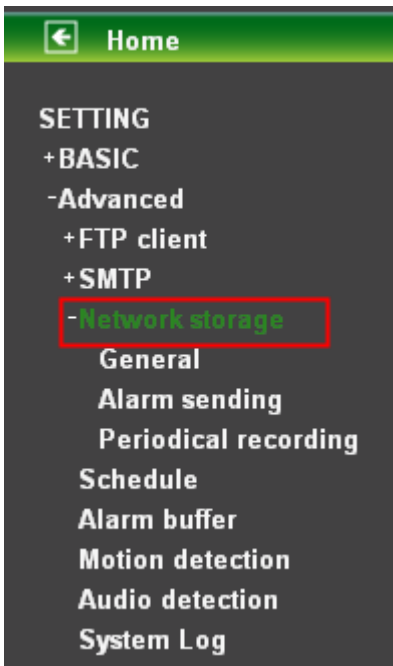

### 8.3.1 General

Select On if you would like to use the network storage function. Then choose one protocol between Windows network (SMB/CIFS) and Unix network (NFS).

➤ **Protocol- Unix Network (NFS):**

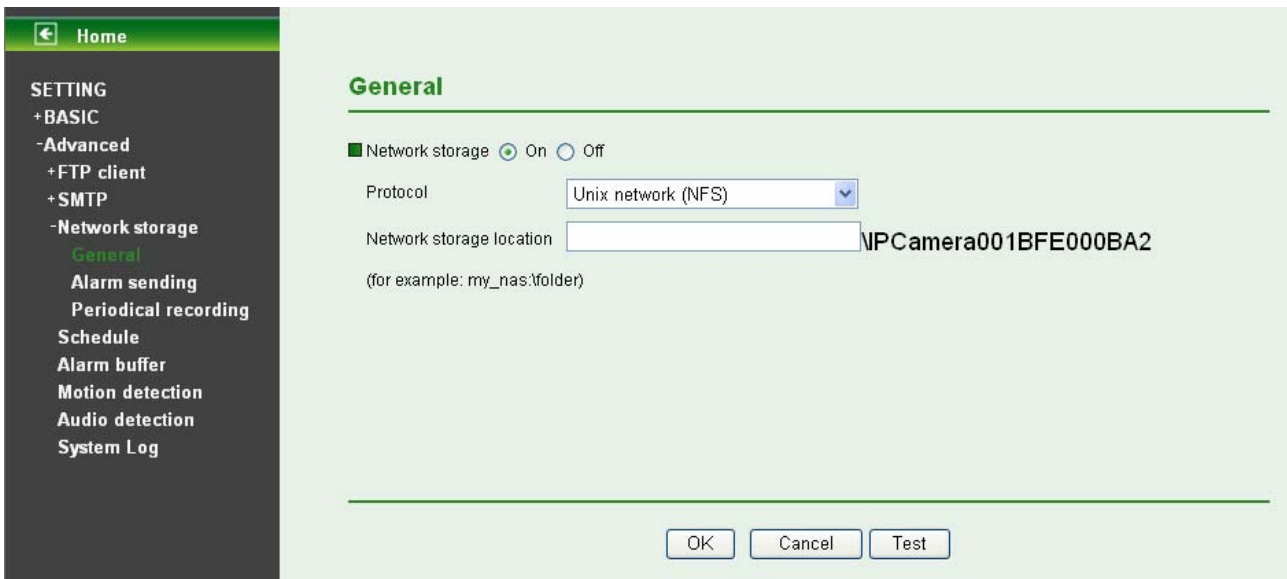

- **Network storage location:** Type the IP or name of specified computer and folder. For example, //IP/folder name or // my\_nas:/folder name.

➤ **Protocol- Windows network (SMB/CIFS):**



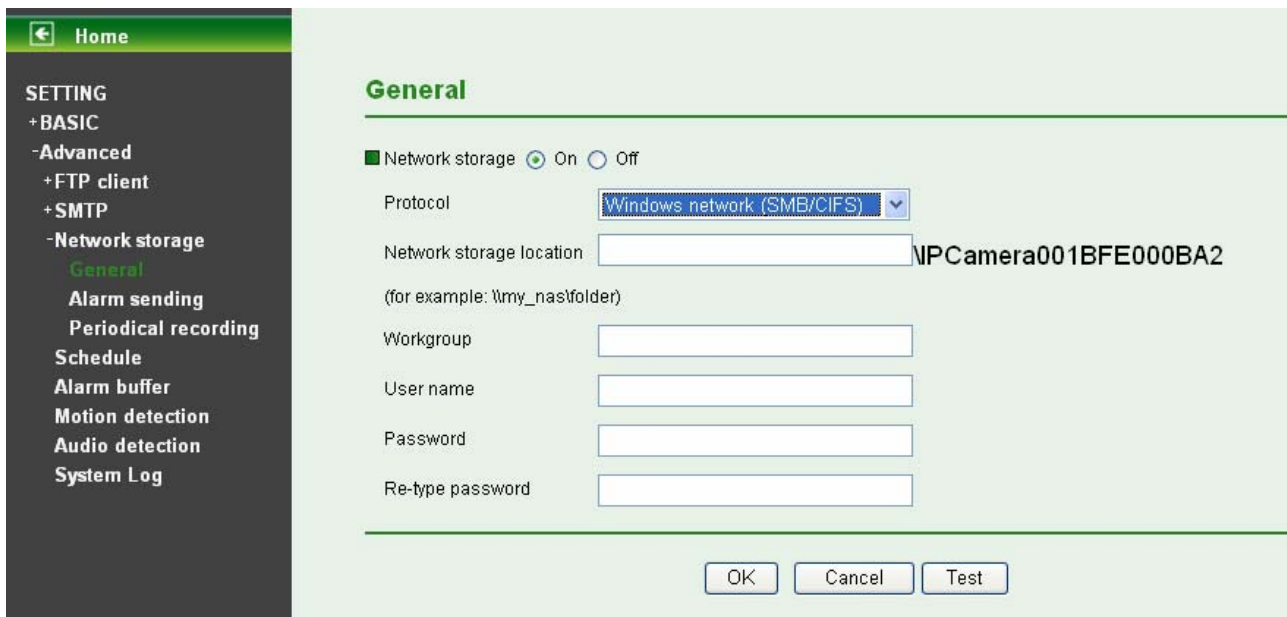

- **Network Storage Location:** Type the IP or name of specified computer and folder. For example, \\IP\folder name or \\my\_nas:\folder name.
- **Workgroup:** Type the name of workgroup which the operating computer belongs.
- **User Name:** Type the name of workgroup. (If none, please leave it blank.)
- **Password:** Type the password for workgroup. (If none, please leave it blank.)
- **Re-type password:** Re-type password for workgroup.

 **Note:**

If the recording video file is assigned to be stored in a low-speed device (ex. low-speed USB storage disk), there might be some problems to complete the storage.

### How to set up the network sharing?

In the following description, we take Windows XP for example to explain how to set up the network sharing. The detailed setup is different in various operation systems. If you have any trouble in setting the network sharing, please ask the Technical Support of Microsoft for help.

You can create a simple Samba network sharing drive on your Windows PC by right-clicking a folder, selecting **Sharing and Security...**, and selecting **Share this folder**. Enter a **Share name** you would like to use for the folder, and then check the below box for **Allow network users to change my files**. After completing the corresponding configurations of the camera, you can click the **Test** button to test your settings.

### 8.3.2 Alarm Sending

Set to transmit the snapshot or video clip file with connection to the alarm detection by the external sensor input or by the built-in motion detection function. Select On to send the file to network storage location linked with the alarm detection.



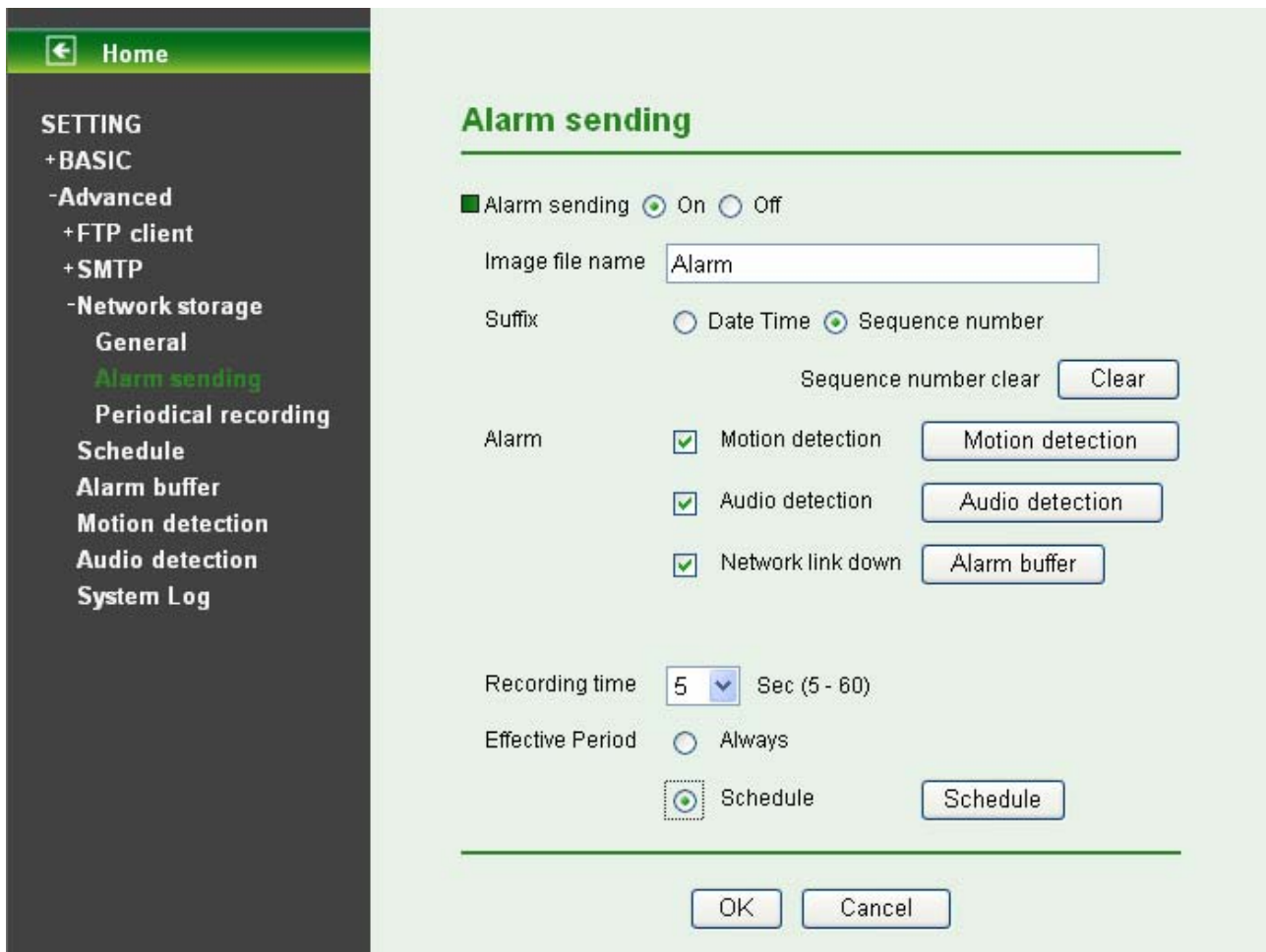

- **Alarm Sending:** Select **On** to set to send mail with connection to the alarm detection.
- **Image File Name:** Type the file name you want to assign to the file to attach a mail. You can use up to 10 alphanumeric, - (hyphen) and \_ (underscore) for naming.
- **Suffix:** Select a suffix to add to the file name
  - **Date & time:** The date & time suffix is added to the Image file name. The date & time suffix consists of lower two-digits of year (2 digits), month (2 digits), date (2 digits), hour (2 digits), minute (2 digits) and second (2 digits), and consecutive number (2 digits), thus 14-digit number is added to the file name.
  - **Sequence number:** A **consecutive** number is added to the Image file name.
  - **Sequence number clear:** Click **Clear** and the suffix of the sequence number returns to 1.
- **Alarm:**
  - **Motion Detection:** Click it on for using **Motion Detection** function as a sensor. You can set motion detection function at the motion detection function screen.

 **Note:**

You can set motion detection at motion detection screen. (Please go “**Setting** → **Advanced** → **Motion Detection** → **Setting**”) For more details, you can check **Chapter 9.6**.

- **Audio Detection:** Click it on for using **Audio Detection** function as a sensor. You can set audio detection function at the audio detection function screen.

 **Note:**

You can set audio detection at audio detection screen. (Please go “**Setting** → **Advanced** → **Audio Detection** → **Setting**”) For more details, you can check **Chapter 9.7**.

- **Network Link Down:** Click it on to receive a video clip while network link down. It's for

recording video file in the IP CAM before and after disconnected network.

 **Note:**

You can set alarm buffer at alarm buffer screen. (Please go “**Setting** → **Advanced** → **Alarm Buffer** → **Setting**”) For more details, you can check **Chapter 9.5**.

- **Effective Period:** Set the period when the periodical sending is effective.
  - **Always:** The periodical sending is always effective.
  - **Schedule:** You can specify the period when the periodical sending is effective in the Schedule setting in the other section.

 **Note:**

You can set schedule function at schedule screen. (Please go “**Setting** → **Advanced** → **Schedule** → **Setting**”) For more details, you can check **Chapter 9.4**.

### 8.3.3 Periodical recording

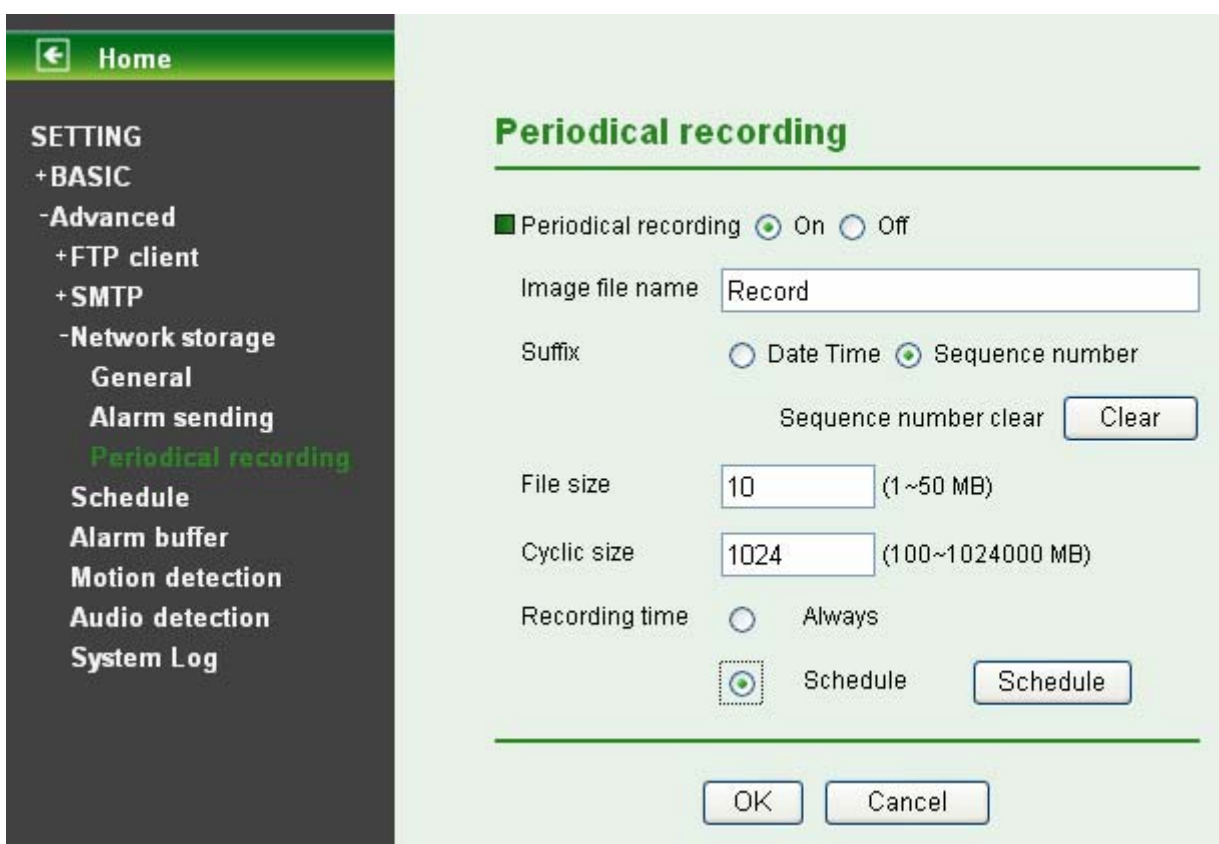

You can set up to transmit image files to the network storage location periodically by selecting **On**.

- **Image file name:** Type the file name you want to assign to the file transmitted to the network storage location. You can use up to 10 alphanumeric, - (hyphen) and \_ (underscore) for naming.
- **Suffix:** Select a suffix to add to the file name
  - **Date & Time:** The date & time suffix is added to the Image file name. The date & time suffix consists of lower two-digits of year (2 digits), month (2 digits), date (2 digits), hour (2 digits), minute (2 digits) and second (2 digits), and consecutive number (2 digits), thus 14-digit number is added to the file name.
  - **Sequence number:** A **consecutive** number is added to the Image file name.
  - **Sequence number clear:** Click **Clear** and the suffix of the sequence number returns to 1.
- **File Size:** The file size of image or video clip transmitted to the network storage location can't over 50MB.

- **Cyclic Size:** The total amount of files transmitted to the network storage location has to be in the range from 100 to 1024000MB.
- **Recording Time:** Set the period when the periodical recording is effective.
  - **Always:** The periodical recording is always effective.
  - **Schedule:** You can specify the period when the periodical recording is effective in the Schedule setting in the other section.

**Note:**

You can set schedule function at schedule screen. (Please go “**Setting** → **Advanced** → **Schedule** → **Setting**”). For more details, you can check **Chapter 9.4**.

## 8.4 Schedule

Click **Schedule** on the **Advanced** mode menu, the Schedule setting menu appears. This is the same menu as the setting menu which is displayed when you click **Schedule** to set Effective period and Schedule in **FTP client**, e-Mail (**SMTP**), Record, and Alarm out setting menu setting menu.

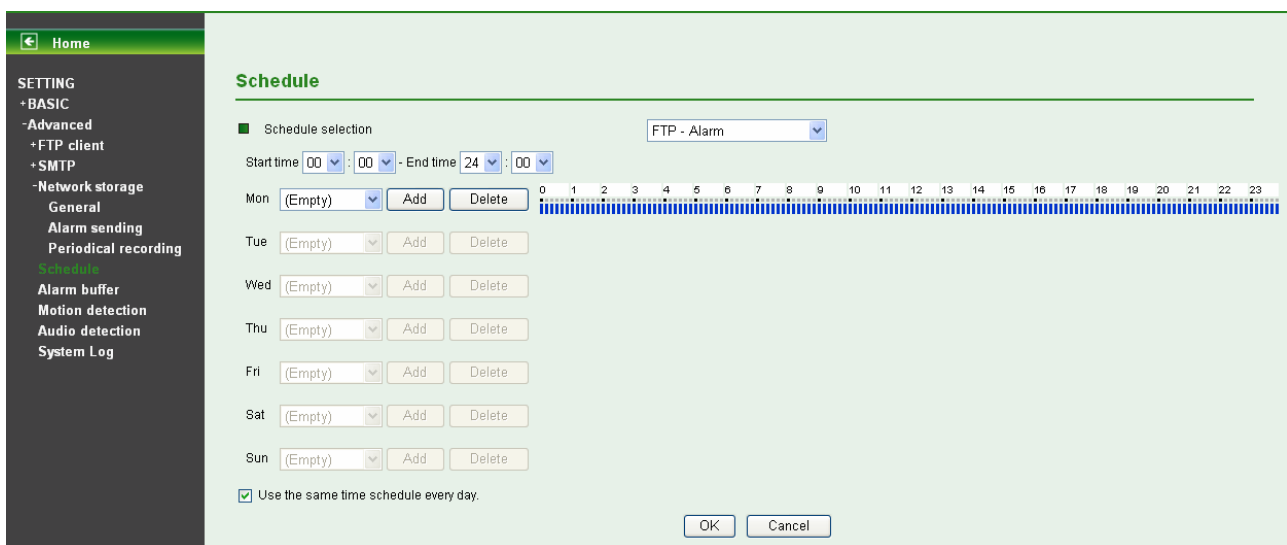

- **Schedule Selection:** Select the list box to specify the schedule you want to set.
  - FTP -Alarm / FTP – Periodical / E-mail (SMTP) -Alarm / E-mail (SMTP) –Periodical / Record –Alarm / Record –Periodical
- **Mon (Monday) to Sun (Sunday):** The time period on the right of the checked day is the effective period of the schedule.
- **Start Time, End Time:** Specify the **Start Time** and the **End Time**.
- **Use the same time schedule every day:** When this is checked, the **Start Time** and **End Time** set to **Mon** (Monday) are applied to all days. In this case, the **Start Time** and **End Time** of the other days than **Mon** (Monday) cannot be input.

## 8.5 Alarm Buffer

When you click **Alarm Buffer** on the **Advanced** mode menu, the Alarm buffer setting menu appears. You can set in this menu to enable alarm buffer function connected with **FTP Client**, **SMTP**, and **Network Storage**.

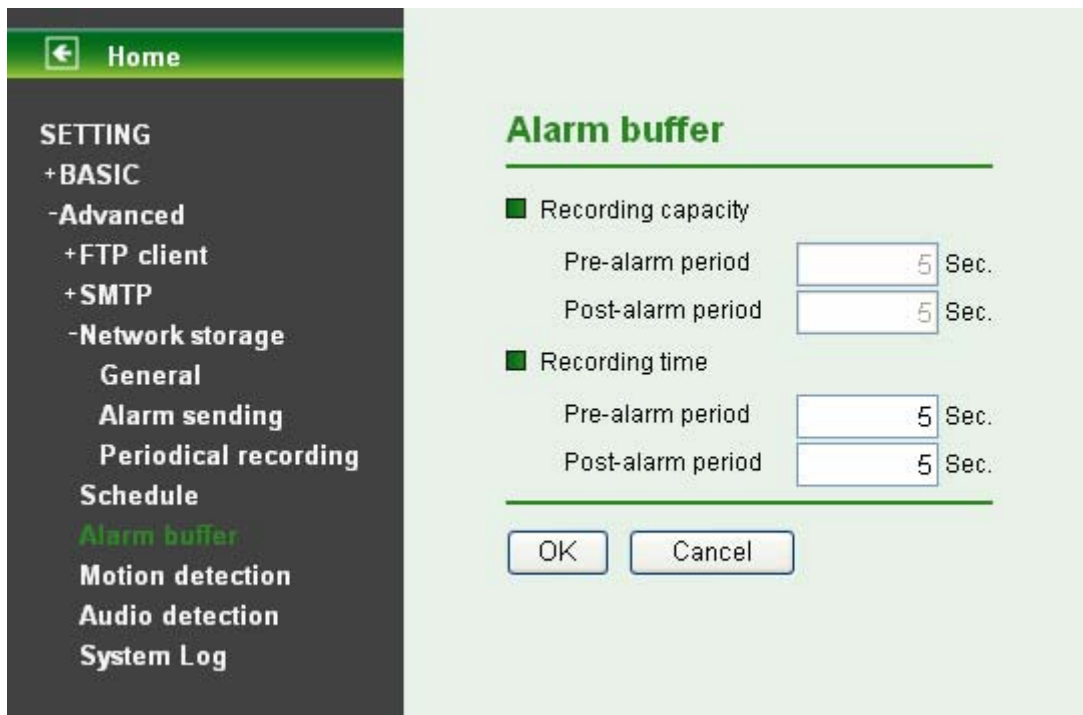

Use alarm buffer function for recording audio and video file in the IP Camera before and after disconnected network. After re-connecting, these files will transmit to **FTP client**, **SMTP**, and **Network storage**. You can set the pre-alarm and post-alarm period up to 5 seconds in Alarm Buffer function screen.

## 8.6 Motion Detection

There are three Motion Detection functions as sensors to set for different detecting zones. Each one has Threshold and Sensitivity inputs which you can adjust to specific zone sequentially. Motion Detection function can support to **FTP Client**, **SMTP**, and **Network Storage**.

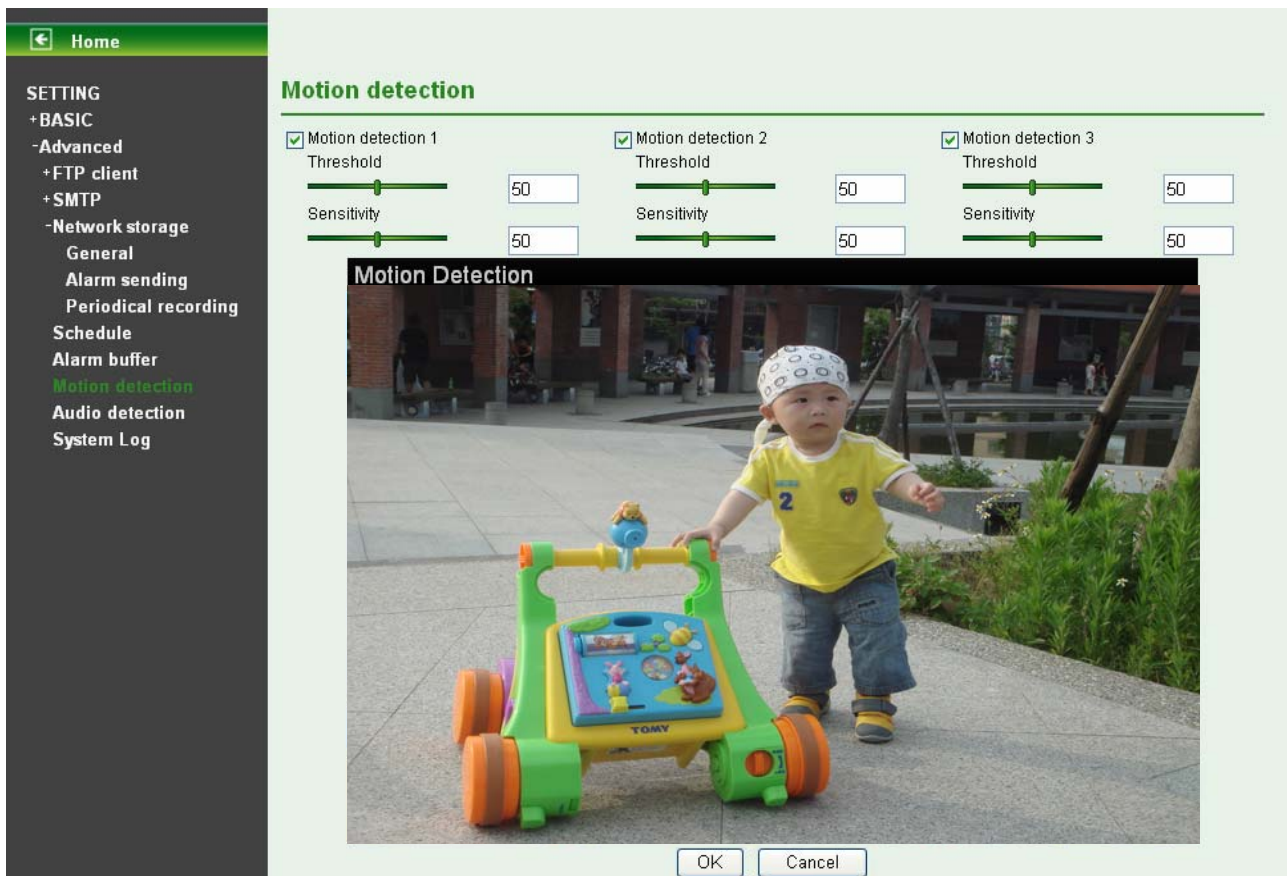

- **Threshold:** It means the extent which the alarm will be triggered. The default value is 50 and the value range is 0~100. The larger the value, the higher the threshold.
- **Sensitivity:** It means that how often the sensor will scan the image different. The higher sensitivity it is and the more frequently it scans. The default value is 50 and the value range is 0~100. The larger the value, the higher the sensitivity.
  - **Motion Detection 1:** Click it on for using **Motion Detection 1** function as a sensor. You can adjust and move the detecting zone by using mouse.
  - **Motion Detection 2:** Click it on for using **Motion Detection 2** function as a sensor. You can adjust and move the detecting zone by using mouse.
  - **Motion Detection 3:** Click it on for using **Motion Detection 3** function as a sensor. You can adjust and move the detecting zone by using mouse.

## 8.7 Audio Detection

The **Audio detection** has Threshold and Sensitivity inputs which you can adjust sequentially. Audio Detection function can support to **FTP Client, SMTP, Network Storage, and HTTP Event**.



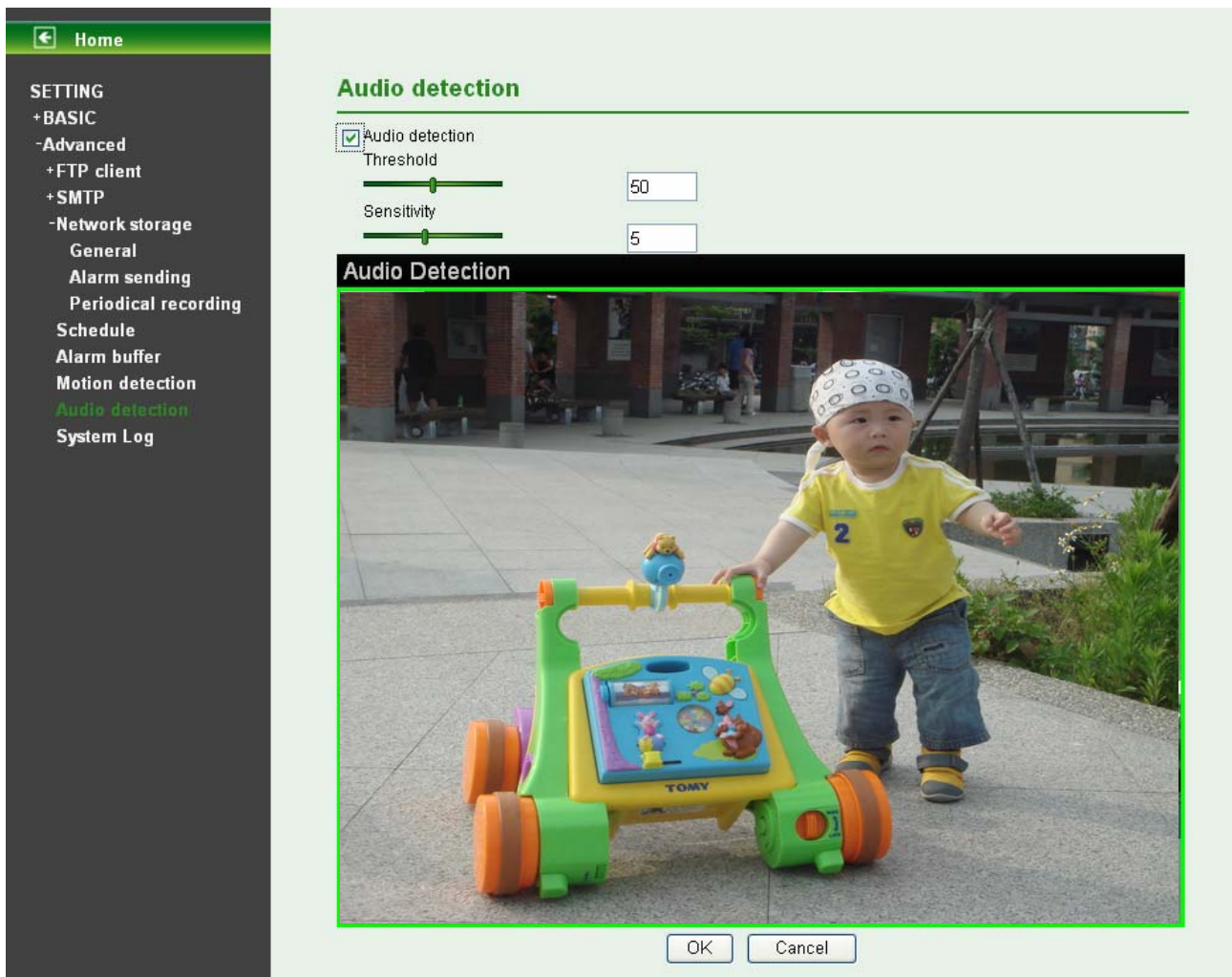

Click it on for using **Audio Detection** function as a sensor. You can set audio detection function at the audio detection function screen.

- **Threshold:** It means the extent which the alarm will be triggered. The default value is 50 and the value range is 0~100. The larger the value, the higher the threshold.
- **Sensitivity:** It means that how often the sensor will scan the image different. The higher sensitivity it is and the more frequently it scans. The default value is 5 and the value range is 1~10. The larger the value, the higher the sensitivity.

## 8.8 System Log

The System Log function allows users to review any changes and events happened. The system starts logging automatically after started.

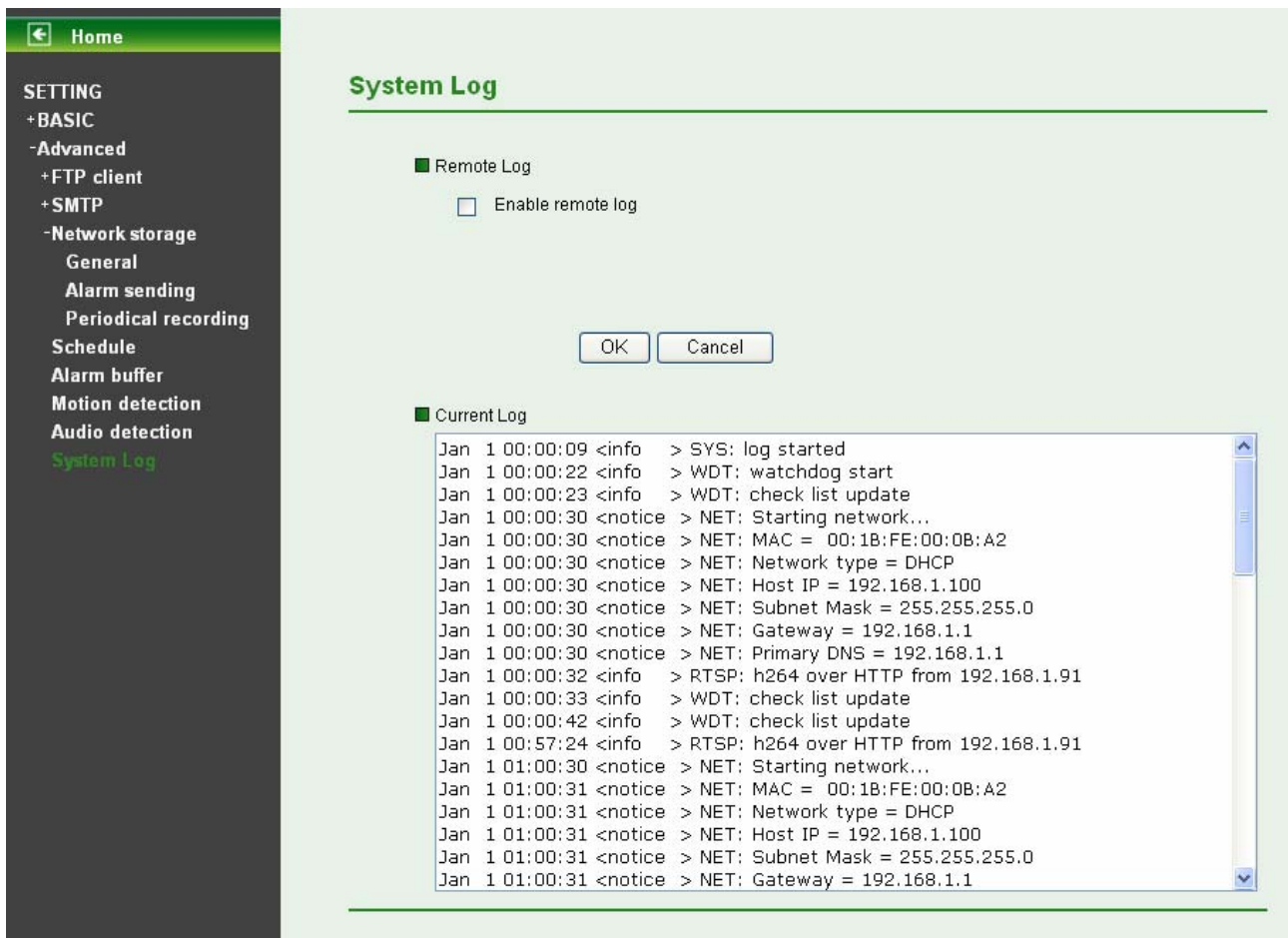

- **Enable Remote Log:** Enables user to send the log data to a specified log server.



## Chapter 9 Appendix

### A. Frame-rate and Bitrate Table – Help to set IPCamera with your network environment to access Internet.

Base on your network upload environment to choose the suitable Image-Quality setting. For example, if the network environment is ADSL 256Kb (upload) / 2Mb (download), the most fluent Image-Quality needs to set up under 256Kb situation.

#### A.1 Mega Mode

##### A.1.1. H.264 @ 15fps / kbps

Quality	1280*1024	1280*720	640*480	320*240
Excellent	<b>1500</b>	<b>1200</b>	<b>180</b>	<b>50</b>
Detailed	<b>400</b>	<b>250</b>	<b>100</b>	<b>30</b>
Good	<b>250</b>	<b>100</b>	<b>80</b>	<b>20</b>
Standard	<b>100</b>	<b>60</b>	<b>50</b>	<b>15</b>
Medium	<b>80</b>	<b>50</b>	<b>40</b>	<b>10</b>

##### A.1.2. H.264 @ 10fps / kbps

Quality	1280*1024	1280*720	640*480	320*240
Excellent	<b>1000</b>	<b>800</b>	<b>120</b>	<b>30</b>
Detailed	<b>280</b>	<b>100</b>	<b>70</b>	<b>20</b>
Good	<b>170</b>	<b>70</b>	<b>55</b>	<b>15</b>
Standard	<b>70</b>	<b>40</b>	<b>30</b>	<b>10</b>
Medium	<b>55</b>	<b>30</b>	<b>20</b>	<b>8</b>

##### A.1.3. H.264 / kbps, fps

Image-Size	Bitrate Setting	Frame-Rate Setting	Current Bitrate	Current Frame-Rate
1280*1024	6144	15	<b>6300</b>	<b>15</b>
1280*1024	6144	10	<b>6300</b>	<b>10</b>
1280*1024	2048	15	<b>2200</b>	<b>15</b>
1280*1024	2048	10	<b>2200</b>	<b>10</b>
1280*1024	512	15	<b>550</b>	<b>15</b>
1280*1024	512	10	<b>550</b>	<b>10</b>
1280*720	6144	15	<b>6300</b>	<b>15</b>
1280*720	6144	10	<b>6300</b>	<b>10</b>
1280*720	2048	15	<b>2200</b>	<b>15</b>
1280*720	2048	10	<b>2200</b>	<b>10</b>
1280*720	512	15	<b>550</b>	<b>15</b>
1280*720	512	10	<b>550</b>	<b>10</b>
640*480	6144	15	<b>6300</b>	<b>15</b>
640*480	6144	10	<b>6300</b>	<b>10</b>
640*480	2048	15	<b>2200</b>	<b>15</b>
640*480	2048	10	<b>2200</b>	<b>10</b>
640*480	512	15	<b>550</b>	<b>15</b>
640*480	512	10	<b>550</b>	<b>15</b>
320*240	6144	15	<b>5100</b>	<b>15</b>
320*240	6144	10	<b>3600</b>	<b>10</b>

320*240	2048	15	<b>2200</b>	<b>15</b>
320*240	2048	10	<b>2200</b>	<b>10</b>
320*240	512	15	<b>550</b>	<b>15</b>
320*240	512	10	<b>550</b>	<b>10</b>

A.1.4. MPEG 4@ 15fps / kbps

Quality	1280*1024	1280*720	640*480	320*240
Excellent	<b>2700</b>	<b>2000</b>	<b>300</b>	<b>100</b>
Detailed	<b>1100</b>	<b>800</b>	<b>200</b>	<b>80</b>
Good	<b>500</b>	<b>350</b>	<b>150</b>	<b>60</b>
Standard	<b>350</b>	<b>250</b>	<b>100</b>	<b>40</b>
Medium	<b>300</b>	<b>200</b>	<b>80</b>	<b>35</b>

A.1.5. MPEG4@ 10fps / kbps

Quality	1280*1024	1280*720	640*480	320*240
Excellent	<b>1800</b>	<b>1400</b>	<b>200</b>	<b>80</b>
Detailed	<b>800</b>	<b>550</b>	<b>120</b>	<b>60</b>
Good	<b>350</b>	<b>250</b>	<b>100</b>	<b>40</b>
Standard	<b>250</b>	<b>180</b>	<b>80</b>	<b>30</b>
Medium	<b>200</b>	<b>140</b>	<b>60</b>	<b>25</b>

A.1.6. MPEG4 / kbps, fps

Image-Size	Quality Setting	Frame-Rate Setting	Current Bitrate	Current Frame-Rate
1280*1024	6144	15	<b>5500</b>	<b>13</b>
1280*1024	6144	10	<b>6300</b>	<b>10</b>
1280*1024	2048	15	<b>2200</b>	<b>15</b>
1280*1024	2048	10	<b>2200</b>	<b>10</b>
1280*1024	512	15	<b>550</b>	<b>15</b>
1280*1024	512	10	<b>550</b>	<b>10</b>
1280*720	6144	15	<b>6300</b>	<b>15</b>
1280*720	6144	10	<b>6300</b>	<b>10</b>
1280*720	2048	15	<b>2200</b>	<b>15</b>
1280*720	2048	10	<b>2200</b>	<b>10</b>
1280*720	512	15	<b>550</b>	<b>15</b>
1280*720	512	10	<b>550</b>	<b>10</b>
640*480	6144	15	<b>6300</b>	<b>15</b>
640*480	6144	10	<b>6300</b>	<b>10</b>
640*480	2048	15	<b>2200</b>	<b>15</b>
640*480	2048	10	<b>2200</b>	<b>10</b>
640*480	512	15	<b>550</b>	<b>15</b>
640*480	512	10	<b>550</b>	<b>10</b>
320*240	6144	15	<b>2200</b>	<b>15</b>
320*240	6144	10	<b>1800</b>	<b>10</b>
320*240	2048	15	<b>2200</b>	<b>15</b>
320*240	2048	10	<b>1800</b>	<b>10</b>
320*240	512	15	<b>550</b>	<b>15</b>
320*240	512	10	<b>550</b>	<b>10</b>

A.1.7. MJPEG @ 15fps / kbps

Quality	1280*1024	1280*720	640*480	320*240
Excellent	<b>22000</b>	<b>16000</b>	<b>6000</b>	<b>2200</b>
Detailed	<b>12000</b>	<b>7000</b>	<b>3000</b>	<b>1200</b>
Good	<b>7000</b>	<b>5000</b>	<b>2500</b>	<b>1000</b>
Standard	<b>5500</b>	<b>4000</b>	<b>2000</b>	<b>800</b>
Medium	<b>4000</b>	<b>3000</b>	<b>1200</b>	<b>500</b>

A.1.8. MJPEG@ 10fps / kbps

Quality	1280*1024	1280*720	640*480	320*240
Excellent	<b>15000</b>	<b>11000</b>	<b>4000</b>	<b>1500</b>
Detailed	<b>8000</b>	<b>5000</b>	<b>2000</b>	<b>800</b>
Good	<b>5000</b>	<b>3500</b>	<b>1800</b>	<b>700</b>
Standard	<b>4000</b>	<b>3000</b>	<b>1500</b>	<b>600</b>
Medium	<b>3000</b>	<b>2000</b>	<b>800</b>	<b>350</b>

A.1.9. MJPEG / kbps, fps

Image-Size	Quality Setting	Frame-Rate Setting	Current Bitrate	Current Frame-Rate
1280*1024	Excellent	15	<b>22000</b>	<b>15</b>
1280*1024	Excellent	10	<b>15000</b>	<b>10</b>
1280*1024	Good	15	<b>7000</b>	<b>15</b>
1280*1024	Good	10	<b>5000</b>	<b>10</b>
1280*1024	Medium	15	<b>4000</b>	<b>15</b>
1280*1024	Medium	10	<b>3000</b>	<b>10</b>
1280*720	Excellent	15	<b>16000</b>	<b>15</b>
1280*720	Excellent	10	<b>11000</b>	<b>10</b>
1280*720	Good	15	<b>5000</b>	<b>15</b>
1280*720	Good	10	<b>3500</b>	<b>10</b>
1280*720	Medium	15	<b>3000</b>	<b>15</b>
1280*720	Medium	10	<b>2000</b>	<b>10</b>
640*480	Excellent	15	<b>6000</b>	<b>15</b>
640*480	Excellent	10	<b>4000</b>	<b>10</b>
640*480	Good	15	<b>2500</b>	<b>15</b>
640*480	Good	10	<b>1800</b>	<b>10</b>
640*480	Medium	15	<b>1200</b>	<b>15</b>
640*480	Medium	10	<b>800</b>	<b>10</b>
320*240	Excellent	15	<b>2200</b>	<b>15</b>
320*240	Excellent	10	<b>1500</b>	<b>10</b>
320*240	Good	15	<b>1000</b>	<b>15</b>
320*240	Good	10	<b>700</b>	<b>10</b>
320*240	Medium	15	<b>500</b>	<b>15</b>
320*240	Medium	10	<b>350</b>	<b>10</b>

**A.2 VGA Mode**

A.2.1 H.264 @ 30fps / kbps

Quality	640*480	320*240
Excellent	<b>600</b>	<b>60</b>
Detailed	<b>120</b>	<b>40</b>

Good	<b>60</b>	<b>30</b>
Standard	<b>50</b>	<b>25</b>
Medium	<b>40</b>	<b>20</b>

A.2.2 H.264@15 fps / kbps

Quality	640*480	320*240
Excellent	<b>400</b>	<b>40</b>
Detailed	<b>80</b>	<b>30</b>
Good	<b>40</b>	<b>25</b>
Standard	<b>30</b>	<b>20</b>
Medium	<b>25</b>	<b>15</b>

A.2.3 H.264 / kbps, fps

Image-Size	Bitrate Setting	Frame-Rate Setting	Current Bitrate	Current Frame-Rate
640*480	6144	30	<b>6300</b>	<b>30</b>
640*480	6144	15	<b>6300</b>	<b>15</b>
640*480	2048	30	<b>2200</b>	<b>30</b>
640*480	2048	15	<b>2200</b>	<b>15</b>
640*480	512	30	<b>550</b>	<b>30</b>
640*480	512	15	<b>550</b>	<b>15</b>
320*240	6144	30	<b>6300</b>	<b>30</b>
320*240	6144	15	<b>5500</b>	<b>15</b>
320*240	2048	30	<b>2200</b>	<b>30</b>
320*240	2048	15	<b>2200</b>	<b>15</b>
320*240	512	30	<b>550</b>	<b>30</b>
320*240	512	15	<b>550</b>	<b>15</b>

A.2.4 MPEG4 @ 30fps / kbps

Quality	640*480	320*240
Excellent	<b>1000</b>	<b>120</b>
Detailed	<b>400</b>	<b>80</b>
Good	<b>200</b>	<b>60</b>
Standard	<b>150</b>	<b>50</b>
Medium	<b>120</b>	<b>40</b>

A.2.5 MPEG4@ 15fps / kbps

Quality	640*480	320*240
Excellent	<b>600</b>	<b>80</b>
Detailed	<b>250</b>	<b>50</b>
Good	<b>150</b>	<b>40</b>
Standard	<b>100</b>	<b>30</b>
Medium	<b>80</b>	<b>20</b>

A.2.6 MPEG4 / kbps, fps

Image-Size	Bitrate Setting	Frame-Rate Setting	Current Bitrate	Current Frame-Rate
640*480	6144	30	<b>6300</b>	<b>30</b>
640*480	6144	15	<b>6300</b>	<b>15</b>

640*480	2048	30	<b>2200</b>	<b>30</b>
640*480	2048	15	<b>2200</b>	<b>15</b>
640*480	512	30	<b>550</b>	<b>30</b>
640*480	512	15	<b>550</b>	<b>15</b>
320*240	6144	30	<b>5100</b>	<b>30</b>
320*240	6144	15	<b>2800</b>	<b>15</b>
320*240	2048	30	<b>2200</b>	<b>30</b>
320*240	2048	15	<b>2200</b>	<b>15</b>
320*240	512	30	<b>550</b>	<b>30</b>
320*240	512	15	<b>550</b>	<b>15</b>

#### A.2.7 MJPEG @ 30fps / kbps

Quality	640*480	320*240
Excellent	<b>13000</b>	<b>4500</b>
Detailed	<b>6500</b>	<b>2500</b>
Good	<b>5000</b>	<b>2000</b>
Standard	<b>4000</b>	<b>1600</b>
Medium	<b>2500</b>	<b>1000</b>

#### A.2.8 MJPEG@ 15fps / kbps

Quality	640*480	320*240
Excellent	<b>7000</b>	<b>2500</b>
Detailed	<b>3500</b>	<b>1500</b>
Good	<b>2800</b>	<b>1200</b>
Standard	<b>2100</b>	<b>1000</b>
Medium	<b>1400</b>	<b>700</b>

#### A.2.9 MJPEG / kbps, fps

Image-Size	Bitrate Setting	Frame-Rate Setting	Current Bitrate	Current Frame-Rate
640*480	Excellent	30	<b>13000</b>	<b>30</b>
640*480	Excellent	15	<b>7000</b>	<b>15</b>
640*480	Good	30	<b>5000</b>	<b>30</b>
640*480	Good	15	<b>2800</b>	<b>15</b>
640*480	Medium	30	<b>2500</b>	<b>30</b>
640*480	Medium	15	<b>1400</b>	<b>15</b>
320*240	Excellent	30	<b>4500</b>	<b>30</b>
320*240	Excellent	15	<b>2500</b>	<b>15</b>
320*240	Good	30	<b>2000</b>	<b>30</b>
320*240	Good	15	<b>1200</b>	<b>15</b>
320*240	Medium	30	<b>1000</b>	<b>30</b>
320*240	Medium	15	<b>700</b>	<b>15</b>

## B. Storage Requirement Table - Help to set Recording Storage System.

Please refer to the following table to find out the capability for recording into your hard disk.

### B.1 Mega Mode

#### B.1.1 H.264 Storage Requirement GB / channel / day @ 15fps

Quality	1280*1024	1280*720	640*480	320*240
---------	-----------	----------	---------	---------

Excellent	<b>50</b>	<b>45</b>	<b>10</b>	<b>4.2</b>
Detailed	<b>16.6</b>	<b>13</b>	<b>8.3</b>	<b>2.5</b>
Good	<b>13</b>	<b>8.3</b>	<b>6.7</b>	<b>1.7</b>
Standard	<b>8.3</b>	<b>5</b>	<b>4.2</b>	<b>1.3</b>
Medium	<b>6.7</b>	<b>4.2</b>	<b>3.4</b>	<b>1</b>

B.1.2 H.264 Storage Requirement GB / channel / day @ 10fps

Quality	1280*1024	1280*720	640*480	320*240
Excellent	<b>45</b>	<b>22.5</b>	<b>6.7</b>	<b>2.5</b>
Detailed	<b>12.5</b>	<b>8.3</b>	<b>5.9</b>	<b>1.7</b>
Good	<b>8.3</b>	<b>5.9</b>	<b>4.6</b>	<b>1.3</b>
Standard	<b>5.9</b>	<b>3.4</b>	<b>2.5</b>	<b>1.3</b>
Medium	<b>4.5</b>	<b>2.5</b>	<b>2.1</b>	<b>0.7</b>

B.1.3 MPEG4 Storage Requirement GB / channel / day

Image-Size	Bitrate Setting	Frame-Rate Setting	Storage Requirement
1280*1024	6144	15	<b>522.9</b>
1280*1024	6144	10	<b>522.9</b>
1280*1024	2048	15	<b>182.6</b>
1280*1024	2048	10	<b>182.6</b>
1280*1024	512	15	<b>45.7</b>
1280*1024	512	10	<b>45.7</b>
1280*720	6144	15	<b>522.9</b>
1280*720	6144	10	<b>522.9</b>
1280*720	2048	15	<b>182.6</b>
1280*720	2048	10	<b>182.6</b>
1280*720	512	15	<b>45.7</b>
1280*720	512	10	<b>45.7</b>
640*480	6144	15	<b>522.9</b>
640*480	6144	10	<b>522.9</b>
640*480	2048	15	<b>182.6</b>
640*480	2048	10	<b>182.6</b>
640*480	512	15	<b>45.7</b>
640*480	512	10	<b>45.7</b>
320*240	6144	15	<b>423.3</b>
320*240	6144	10	<b>298.8</b>
320*240	2048	15	<b>182.6</b>
320*240	2048	10	<b>182.6</b>
320*240	512	15	<b>45.7</b>
320*240	512	10	<b>45.7</b>

B.1.4 MPEG4 Storage Requirement GB / channel / day @ 15fps

Quality	1280*1024	1280*720	640*480	320*240
Excellent	<b>133</b>	<b>83</b>	<b>25</b>	<b>8.3</b>
Detailed	<b>58.1</b>	<b>42</b>	<b>17</b>	<b>6.7</b>
Good	<b>42</b>	<b>25</b>	<b>12.5</b>	<b>5</b>
Standard	<b>30</b>	<b>21</b>	<b>8.3</b>	<b>3.4</b>
Medium	<b>25</b>	<b>17</b>	<b>6.7</b>	<b>3</b>

B.1.5 MPEG4 Storage Requirement GB / channel / day @ 10fps

Quality	1280*1024	1280*720	640*480	320*240
Excellent	<b>92</b>	<b>58.1</b>	<b>17</b>	<b>6.7</b>
Detailed	<b>42</b>	<b>30</b>	<b>10</b>	<b>5</b>
Good	<b>30</b>	<b>17</b>	<b>8.3</b>	<b>3.4</b>
Standard	<b>21</b>	<b>12.5</b>	<b>6.7</b>	<b>2.5</b>
Medium	<b>17</b>	<b>10</b>	<b>5</b>	<b>2</b>

B.1.6 MPEG4 Storage Requirement GB / channel / day

Image-Size	Quality Setting	Frame-Rate Setting	Storage Requirement
1280*1024	6144	15	<b>431.6</b>
1280*1024	6144	10	<b>522.9</b>
1280*1024	2048	15	<b>182.6</b>
1280*1024	2048	10	<b>182.6</b>
1280*1024	512	15	<b>45.7</b>
1280*1024	512	10	<b>45.7</b>
1280*720	6144	15	<b>522.9</b>
1280*720	6144	10	<b>522.9</b>
1280*720	2048	15	<b>182.6</b>
1280*720	2048	10	<b>182.6</b>
1280*720	512	15	<b>45.7</b>
1280*720	512	10	<b>45.7</b>
640*480	6144	15	<b>522.9</b>
640*480	6144	10	<b>522.9</b>
640*480	2048	15	<b>182.6</b>
640*480	2048	10	<b>182.6</b>
640*480	512	15	<b>45.7</b>
640*480	512	10	<b>45.7</b>
320*240	6144	15	<b>182.6</b>
320*240	6144	10	<b>149.4</b>
320*240	2048	15	<b>182.6</b>
320*240	2048	10	<b>149.4</b>
320*240	512	15	<b>45.7</b>
320*240	512	10	<b>45.7</b>

**B.2 VGA Mode**

B.2.1. H.264 Storage Requirement GB / channel / day @ 30fps

Quality	640*480	320*240
Excellent	<b>21</b>	<b>5</b>
Detailed	<b>10</b>	<b>3.4</b>
Good	<b>5</b>	<b>2.5</b>
Standard	<b>4.2</b>	<b>2.1</b>
Medium	<b>3.4</b>	<b>1.7</b>

B.2.2. H.264 Storage Requirement GB / channel / day @ 15fps

Quality	640*480	320*240
Excellent	<b>12.5</b>	<b>3.4</b>
Detailed	<b>6.7</b>	<b>2.5</b>
Good	<b>3.4</b>	<b>2.1</b>



Standard	<b>2.5</b>	<b>1.7</b>
Medium	<b>2.1</b>	<b>1.3</b>

B.2.3. H.264 Storage Requirement GB / channel / day

Image-Size	Bitrate Setting	Frame-Rate Setting	Current Bitrate	Storage Requirement
640*480	6144	30	<b>6300</b>	<b>522.9</b>
640*480	6144	15	<b>6300</b>	<b>522.9</b>
640*480	2048	30	<b>2200</b>	<b>182.6</b>
640*480	2048	15	<b>2200</b>	<b>182.6</b>
640*480	512	30	<b>550</b>	<b>45.7</b>
640*480	512	15	<b>550</b>	<b>45.7</b>
320*240	6144	30	<b>6300</b>	<b>522.9</b>
320*240	6144	15	<b>5500</b>	<b>456.5</b>
320*240	2048	30	<b>2200</b>	<b>182.6</b>
320*240	2048	15	<b>2200</b>	<b>182.6</b>
320*240	512	30	<b>550</b>	<b>45.7</b>
320*240	512	15	<b>550</b>	<b>45.7</b>

B.2.4. MPEG4 Storage Requirement GB / channel / day @ 30fps

Quality	640*480	320*240
Excellent	<b>50</b>	<b>10</b>
Detailed	<b>25</b>	<b>6.7</b>
Good	<b>16.7</b>	<b>5</b>
Standard	<b>12.5</b>	<b>4.2</b>
Medium	<b>10</b>	<b>3.4</b>

B.2.5. MPEG4 Storage Requirement GB / channel / day @ 15fps

Quality	640*480	320*240
Excellent	<b>33.2</b>	<b>6.7</b>
Detailed	<b>16.7</b>	<b>4.2</b>
Good	<b>12.5</b>	<b>3.4</b>
Standard	<b>8.3</b>	<b>2.5</b>
Medium	<b>6.7</b>	<b>1.7</b>

B.2.6. MJPEG Storage Requirement GB / channel / day

Image-Size	Bitrate Setting	Frame-Rate Setting	Current Bitrate	Storage Requirement
640*480	6144	30	<b>6300</b>	<b>522.9</b>
640*480	6144	15	<b>6300</b>	<b>522.9</b>
640*480	2048	30	<b>2200</b>	<b>182.6</b>
640*480	2048	15	<b>2200</b>	<b>182.6</b>
640*480	512	30	<b>550</b>	<b>45.7</b>
640*480	512	15	<b>550</b>	<b>45.7</b>
320*240	6144	30	<b>5100</b>	<b>423.3</b>
320*240	6144	15	<b>2800</b>	<b>232.4</b>
320*240	2048	30	<b>2200</b>	<b>182.6</b>
320*240	2048	15	<b>2200</b>	<b>182.6</b>
320*240	512	30	<b>550</b>	<b>45.7</b>

320*240	512	15	<b>550</b>	<b>45.7</b>
---------	-----	----	------------	-------------

## C. System Requirement – Help to setup System

### C.1. 16 Channel IPCamera with CIF Performance

Equipment Configuration

<b>Software:</b>	MainConsole Version 2.6.4 Professional
<b>CPU:</b>	Intel Core 2 Quad Q6600 @ 2400 MHz
<b>Memory:</b>	1024 MB (2 x 512 DDR2-SDRAM )
<b>Ethernet:</b>	Marvell Yukon 88E8052 PCI-E ASF Gigabit Ethernet Controller
<b>Hard Disk:</b>	ST3250620A (250 GB)
<b>Graphic card:</b>	ATI Technologies Inc Radeon X1300 Series
<b>Operating System:</b>	Windows XP Professional SP2

Results from Test with a Resolution of 352×240

<b>320x240</b>	<b>Quality</b>	<b>Frame Rate</b>	<b>CPU Load</b>	<b>Bandwidth</b>
16 IP camera	Good	20	65%	40~50 Mbps
16 IP camera	Excellent	20	67%	40~50 Mbps

### C.2. 16 Channel IPCamera with D1 Performance

Equipment Configuration

<b>Software:</b>	MainConsole Version 2.6.4 Professional
<b>CPU:</b>	AMD Athlon 64*2 @3600+MHz
<b>Memory:</b>	2048 MB (2 x 1024 DDR2-SDRAM )
<b>Ethernet:</b>	VIA Rhine II Fast Ethernet Adapter
<b>Hard Disk:</b>	ST3250620A (250 GB)
<b>Graphic card:</b>	ATI Technologies Inc EAX1600 Series
<b>Operating System:</b>	Windows XP Professional SP2 x64

Results from Test with a Resolution of 704×480 CCD IPCamera

<b>704x480</b>	<b>Quality</b>	<b>Frame Rate</b>	<b>CPU Load</b>	<b>Bandwidth</b>
16 IP camera	Excellent	30	95%	15~20 Mbps

Results from Test with a Resolution of 640×480 CMOS IPCamera

<b>640x480</b>	<b>Quality</b>	<b>Frame Rate</b>	<b>CPU Load</b>	<b>Bandwidth</b>
16 IP camera	Excellent	30	95%	10~15 Mbps

## Europe – EU Declaration of Conformity







This device complies with the essential requirements of the R&TTE Directive 1999/5/EC. The following test methods have been applied in order to prove presumption of conformity with the essential requirements of the R&TTE Directive 1999/5/EC:











Clause	Description
<b>EN 60950-1: 2001</b>	Safety of Information Technology Equipment
<b>EN 50392: 2004</b>	Generic standard to demonstrate the compliance of electronic and electrical apparatus with the basic restrictions related to human exposure to electromagnetic fields (0 Hz - 300 GHz)
<b>EN 300 328 V1.6.1 (2004-11)</b>	Electromagnetic compatibility and Radio spectrum Matters (ERM); Wideband transmission systems; Data transmission equipment operating in the 2,4 GHz ISM band and using wide band modulation techniques; Harmonized EN covering essential requirements under article 3.2 of the R&TTE Directive
<b>EN 301 489-17 V1.2.1 (2002-08) and EN 301 489-1 V1.5.1 (2004-11)</b>	Electromagnetic compatibility and Radio spectrum Matters (ERM); ElectroMagnetic Compatibility (EMC) standard for radio equipment and services; Part 17: Specific conditions for 2,4 GHz wideband transmission systems and 5 GHz high performance RLAN equipment

This device is a 2.4 GHz wideband transmission system (transceiver), intended for use in all EU member states and EFTA countries, except in France and Italy where restrictive use applies.

In Italy the end-user should apply for a license at the national spectrum authorities in order to obtain authorization to use the device for setting up outdoor radio links and/or for supplying public access to telecommunications and/or network services.

This device may not be used for setting up outdoor radio links in France and in some areas the RF output power may be limited to 10 mW EIRP in the frequency range of 2454 – 2483.5 MHz. For detailed information the end-user should contact the national spectrum authority in France.

 Český [Czech]	<i>[Jméno výrobce]</i> tímto prohlašuje, že tento <i>[typ zařízení]</i> je ve shodě se základními požadavky a dalšími příslušnými ustanoveními směrnice 1999/5/ES.
 Dansk [Danish]	Undertegnede <i>[fabrikantens navn]</i> erklærer herved, at følgende udstyr <i>[udstyrets typebetegnelse]</i> overholder de væsentlige krav og øvrige relevante krav i direktiv 1999/5/EF.
 Deutsch [German]	Hiermit erkläre <i>[Name des Herstellers]</i> , dass sich das Gerät <i>[Gerätetyp]</i> in Übereinstimmung mit den grundlegenden Anforderungen und den übrigen einschlägigen Bestimmungen der Richtlinie 1999/5/EG befindet.
 Eesti [Estonian]	Käesolevaga kinnitab <i>[tootja nimi = name of manufacturer]</i> seadme <i>[seadme tüüp = type of equipment]</i> vastavust direktiivi 1999/5/EÜ põhinõuetele ja nimetatud direktiivist tulenevatele teistele asjakohastele sätetele.
 English	Hereby, <i>[name of manufacturer]</i> , declares that this <i>[type of equipment]</i> is in compliance with the essential requirements and other relevant provisions of Directive 1999/5/EC.
 Español	Por medio de la presente <i>[nombre del fabricante]</i> declara que el <i>[clase de equipo]</i>

[Spanish]	cumple con los requisitos esenciales y cualesquiera otras disposiciones aplicables o exigibles de la Directiva 1999/5/CE.
 Ελληνική [Greek]	ΜΕ ΤΗΝ ΠΑΡΟΥΣΑ [ <i>name of manufacturer</i> ] ΔΗΛΩΝΕΙ ΟΤΙ [ <i>type of equipment</i> ] ΣΥΜΜΟΡΦΩΝΕΤΑΙ ΠΡΟΣ ΤΙΣ ΟΥΣΙΩΔΕΙΣ ΑΠΑΙΤΗΣΕΙΣ ΚΑΙ ΤΙΣ ΛΟΙΠΕΣ ΣΧΕΤΙΚΕΣ ΔΙΑΤΑΞΕΙΣ ΤΗΣ ΟΔΗΓΙΑΣ 1999/5/ΕΚ.
 Français [French]	Par la présente [ <i>nom du fabricant</i> ] déclare que l'appareil [ <i>type d'appareil</i> ] est conforme aux exigences essentielles et aux autres dispositions pertinentes de la directive 1999/5/CE.
 Italiano [Italian]	Con la presente [ <i>nome del costruttore</i> ] dichiara che questo [ <i>tipo di apparecchio</i> ] è conforme ai requisiti essenziali ed alle altre disposizioni pertinenti stabilite dalla direttiva 1999/5/CE.
Latviski [Latvian]	Ar šo [ <i>name of manufacturer / izgatavotāja nosaukums</i> ] deklarē, ka [ <i>type of equipment / iekārtas tips</i> ] atbilst Direktīvas 1999/5/EK būtiskajām prasībām un citiem ar to saistītajiem noteikumiem.
Lietuvių [Lithuanian]	Šiuo [ <i>manufacturer name</i> ] deklaruoja, kad šis [ <i>equipment type</i> ] atitinka esminius reikalavimus ir kitas 1999/5/EB Direktyvos nuostatas.
 Nederlands [Dutch]	Hierbij verklaart [ <i>naam van de fabrikant</i> ] dat het toestel [ <i>type van toestel</i> ] in overeenstemming is met de essentiële eisen en de andere relevante bepalingen van richtlijn 1999/5/EG.
 Malti [Maltese]	Hawnhekk, [ <i>isem tal-manifattur</i> ], jiddikjara li dan [ <i>il-mudel tal-prodott</i> ] jikkonforma mal-ħtiġijiet essenzjali u ma provvedimenti oħrajn rilevanti li hemm fid-Dirrettiva 1999/5/EC.
 Magyar [Hungarian]	Alulírott, [ <i>gyártó neve</i> ] nyilatkozom, hogy a [ <i>... típus</i> ] megfelel a vonatkozó alapvető követelményeknek és az 1999/5/EC irányelv egyéb előírásainak.
 Polski [Polish]	Niniejszym [ <i>nazwa producenta</i> ] oświadczam, że [ <i>nazwa wyrobu</i> ] jest zgodny z zasadniczymi wymogami oraz pozostałymi stosownymi postanowieniami Dyrektywy 1999/5/EC.
 Português [Portuguese]	[ <i>Nome do fabricante</i> ] declara que este [ <i>tipo de equipamento</i> ] está conforme com os requisitos essenciais e outras disposições da Directiva 1999/5/CE.
 Slovensko [Slovenian]	[ <i>Ime proizvajalca</i> ] izjavlja, da je ta [ <i>tip opreme</i> ] v skladu z bistvenimi zahtevami in ostalimi relevantnimi določili direktive 1999/5/ES.
Slovensky [Slovak]	[ <i>Meno výrobcu</i> ] týmto vyhlasuje, že [ <i>typ zariadenia</i> ] spĺňa základné požiadavky a všetky príslušné ustanovenia Smernice 1999/5/ES.
 Suomi [Finnish]	[ <i>Valmistaja = manufacturer</i> ] vakuuttaa täten että [ <i>type of equipment = laitteen tyyppimerkintä</i> ] tyyppinen laite on direktiivin 1999/5/EY oleellisten vaatimusten ja sitä koskevien direktiivin muiden ehtojen mukainen.
 Svenska [Swedish]	Härmed intygar [ <i>företag</i> ] att denna [ <i>utrustningstyp</i> ] står i överensstämmelse med de väsentliga egenskapskrav och övriga relevanta bestämmelser som framgår av

	direktiv 1999/5/EG.
--	---------------------

## **Federal Communication Commission Interference Statement**

This equipment has been tested and found to comply with the limits for a Class B digital device, pursuant to Part 15 of the FCC Rules. These limits are designed to provide reasonable protection against harmful interference in a residential installation. This equipment generates, uses and can radiate radio frequency energy and, if not installed and used in accordance with the instructions, may cause harmful interference to radio communications. However, there is no guarantee that interference will not occur in a particular installation. If this equipment does cause harmful interference to radio or television reception, which can be determined by turning the equipment off and on, the user is encouraged to try to correct the interference by one of the following measures:

- Reorient or relocate the receiving antenna.
- Increase the separation between the equipment and receiver.
- Connect the equipment into an outlet on a circuit different from that to which the receiver is connected.
- Consult the dealer or an experienced radio/TV technician for help.

This device complies with Part 15 of the FCC Rules. Operation is subject to the following two conditions:

- (1) This device may not cause harmful interference, and
- (2) this device must accept any interference received, including interference that may cause undesired operation.

### **FCC Caution:**

Any changes or modifications not expressly approved by the party responsible for compliance could void the user's authority to operate this equipment.

IEEE 802.11b or 802.11g operation of this product in the U.S.A. is firmware-limited to channels 1 through 11.

### **IMPORTANT NOTE:**

#### **FCC Radiation Exposure Statement:**

This equipment complies with FCC radiation exposure limits set forth for an uncontrolled environment. This equipment should be installed and operated with minimum distance 20cm between the radiator & your body.

This transmitter must not be co-located or operating in conjunction with any other antenna or transmitter.